

NAVAL SHIPS' TECHNICAL MANUAL
CHAPTER 075
FASTENERS

THIS CHAPTER SUPERSEDES NSTM CHAPTER 075 DATED 15 SEPTEMBER 1997

DISTRIBUTION STATEMENT A: APPROVED FOR PUBLIC RELEASE; DISTRIBUTION IS UNLIMITED.

PUBLISHED BY DIRECTION OF COMMANDER, NAVAL SEA SYSTEMS COMMAND

1 DEC 1997

NAVSEA TECHNICAL MANUAL CERTIFICATION SHEET						1 of 1
Certification Applies to: New Manual <input type="checkbox"/> Revision <input checked="" type="checkbox"/> Change <input type="checkbox"/>						
Applicable TMINS/Pub. No. <u>S9086-CJ-STM-010/CH-075R2</u>						
Publication Date (Mo, Da, Yr) <u>December 1, 1997</u>						
Title: <u>NSTM Chapter 075, Fasteners</u>						
TMCN/TMSR/Specification No: _____						
CHANGES AND REVISIONS:						
Purpose: <u>To change page 3-29 paragraph 075-3.4.3.3.2 subparagraph b to delete "nuts" in four places and insert "fasteners."</u>						

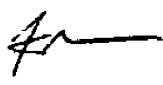
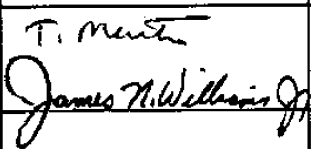
Equipment Alteration Numbers Incorporated: _____						
TMDER/ACN Numbers Incorporated: _____						
<i>Continue on reverse side or add pages as needed.</i>						
CERTIFICATION STATEMENT						
This is to certify that responsible NAVSEA activities have reviewed the above identified document for acquisition compliance, technical coverage, and printing quality. This form is for internal NAVSEA management use only, and does not imply contractual approval or acceptance of the technical manual by the Government, nor relieve the contractor of any responsibility for delivering the technical manual in accordance with the contract requirement.						
Authority	Name	Signature	Organization	Code	Date	
Acquisition	K. P. ROEY		NAVSEA	03W	12/1/97	
Technical	T.M. MERTEN J.N. WILLIAMS		NAVSEA NAVSEA	03W1 03W14	12/1/97 12/1/97	
Printing Release	Digital Media Publishing					

Certificaton Sheet

TABLE OF CONTENTS

Chapter/Paragraph	Page
075 FASTENERS	75-1
SECTION 1. INTRODUCTION TO THREADED FASTENERS	75-1
075-1.1 SCOPE	75-1
075-1.1.1 GENERAL.	75-1
075-1.1.2 REFERENCE DOCUMENTS.	75-1
075-1.2 GENERAL	75-2
075-1.2.1 USING FASTENERS.	75-2
075-1.2.2 FASTENER MAINTENANCE PRACTICES.	75-3
075-1.2.3 HI SHOCK.	75-3
075-1.2.4 GLOSSARY OF TERMS.	75-4
SECTION 2. IDENTIFICATION OF FASTENERS	75-7
075-2.1 GENERAL	75-7
075-2.2 THREAD CLASS, FIT, SERIES, AND DESIGNATION	75-8
075-2.2.1 THREAD CLASSES.	75-8
075-2.2.1.1 Class 1.	75-8
075-2.2.1.2 Class 2.	75-8
075-2.2.1.3 Class 3.	75-8
075-2.2.1.4 Class 5.	75-8
075-2.2.2 THREAD FIT.	75-8
075-2.2.2.1 Class 1, 2, and 3 Fit.	75-8
075-2.2.2.2 Class 5 Fit.	75-9
075-2.2.3 THREAD SERIES.	75-9
075-2.2.3.1 UNC (Coarse Thread) Series.	75-9
075-2.2.3.2 UNF (Fine Thread) Series.	75-9
075-2.2.3.3 UN (Constant Pitch Thread) Series.	75-9
075-2.2.3.4 UNJ.	75-9
075-2.2.3.5 NC (National Coarse Thread) Series.	75-9
075-2.2.4 THREAD DESIGNATION.	75-9
075-2.2.5 THREAD ACCEPTABILITY, GAUGING.	75-10
075-2.2.5.1 Fastener Fit Requirements.	75-10
075-2.2.6 THREAD GAUGES.	75-10
075-2.3 IDENTIFYING REPLACEMENT FASTENERS	75-11
075-2.3.1 DRAWING IDENTIFICATION REQUIREMENTS.	75-11
075-2.3.2 IDENTIFYING FASTENERS ON APL'S.	75-12
075-2.3.3 IDENTIFYING FASTENERS AND FASTENER STANDARD PART NUMBERS WHEN SUPPORT DOCUMENTATION IS LACKING.	75-12
075-2.4 CAPSCREWS AND INTERNAL WRENCHING BOLTS	75-14
075-2.4.1 SOCKET-HEAD CAP SCREWS.	75-14

TABLE OF CONTENTS - Continued

Chapter/Paragraph	Page
075-2.4.1.1	Selecting Dimensional Standard 75-14
075-2.4.1.2	NAS 1351 and NAS 1352 Part Numbers. 75-18
075-2.4.1.3	Authorized Socket-Head Capscrew Substitutions. 75-19
075-2.4.1.4	Socket-Head Capscrew Substitution Requiring NAVSEA Approval. 75-20
075-2.4.1.5	Identification of Socket Head Cap Screws. 75-20
075-2.4.2	INTERNAL WRENCHING BOLTS. 75-21
075-2.4.2.1	Distinguishing Internal Wrenching Bolts from Socket-Head Capscrews. 75-21
075-2.4.2.2	Identification Marking of Internal Wrenching Bolts. 75-21
075-2.4.2.3	Restrictions on Using Internal Wrenching Bolts. 75-21
075-2.4.3	HEXAGON-HEAD CAPSCREWS. 75-22
075-2.4.3.1	ASME B 18.2.1 Part Numbering System. 75-22
075-2.4.3.2	Zinc and Cadmium Plated Hex Head Cap Screws. 75-23
075-2.4.3.3	Restrictions on the Use of Grade 8, Zinc Plated Hex Head Cap Screws. 75-26
075-2.5	WASHERS 75-26
075-2.5.1	IDENTIFYING REPLACEMENT WASHERS. 75-26
075-2.5.2	COUNTERSUNK WASHERS (SINGLE SURFACE). 75-27
075-2.5.3	COUNTERSUNK WASHERS (TWO SURFACES). 75-27
075-2.5.4	LOCKWASHERS. 75-27
075-2.6	ZINC-PLATED STEEL NUTS AND WASHERS 75-27
075-2.7	THREAD INSERTS 75-27
075-2.7.1	PURPOSE OF THREAD INSERT. 75-27
075-2.8	NONSTANDARD FASTENER APPLICATIONS 75-28
075-2.8.1	LEFT-HAND THREAD APPLICATIONS. 75-28
075-2.8.2	UNIFORM STRENGTH FASTENERS. 75-30
075-2.8.2.1	Bolt-Studs. 75-30
075-2.8.3	HOLES FOR UNIFORM STRENGTH FASTENERS. 75-31
SECTION 3.	THREADED FASTENER MATERIALS AND MARKING 75-35
075-3.1	GENERAL 75-35
075-3.2	MATERIAL REQUIREMENTS AND SPECIFICATIONS 75-35
075-3.2.1	FASTENER REQUIREMENTS FOR MIC LEVEL I APPLICATIONS. 75-35
075-3.2.2	LEVEL I REQUIREMENTS FOR FASTENERS. 75-35
075-3.2.2.1	Procurement Specifications. 75-35
075-3.2.2.2	Fastener Identification and Control. 75-35
075-3.2.2.3	Color Coding. 75-36
075-3.2.3	FASTENER MATERIAL CHARACTERISTICS, IDENTIFICATION MARKINGS AND SUGGESTED USE. 75-36
075-3.2.3.1	Chemical and Physical Properties. 75-36

TABLE OF CONTENTS - Continued

Chapter/Paragraph	Page	
075-3.2.3.2	Material Identification Markings.	75-36
075-3.2.3.3	Material Identification Markings for Stainless Steel Fasteners.	75-37
075-3.2.3.4	Identifying Material When Fasteners Are Not Marked.	75-37
075-3.2.3.5	Manufacturer's Markings.	75-37
075-3.3	MIL-S-1222 FASTENERS.	75-37
075-3.3.1	BACKGROUND.	75-37
075-3.3.2	MIL-S-1222 FASTENER MATERIAL MARKING.	75-38
075-3.3.2.1	300 Series Stainless.	75-38
075-3.3.2.2	400 Series Stainless Steel.	75-38
075-3.3.2.3	Marking Locations.	75-38
075-3.3.3	AVAILABILITY	75-39
075-3.3.3.1	Fastener Part Numbers.	75-39
075-3.3.3.2	Other Sources.	75-39
075-3.4	ISSUES AFFECTING MATERIAL SELECTION	75-58
075-3.4.1	CORROSION.	75-58
075-3.4.1.1	Oxidation.	75-58
075-3.4.1.2	Galvanic Corrosion.	75-58
075-3.4.1.3	Design Considerations to Reduce or Eliminate Corrosion.	75-59
075-3.4.2	HYDROGEN EMBRITTLEMENT AND STRESS CORROSION CRACKING.	75-60
075-3.4.2.1	High-Strength Steel Fasteners.	75-60
075-3.4.3	COATINGS.	75-62
075-3.4.3.1	Corrosion Protection.	75-62
075-3.4.3.2	Zinc and Cadmium Coatings.	75-63
075-3.4.3.3	Black Oxide Coated Fasteners.	75-63
075-3.4.3.4	Zinc Primer Coating in Accordance with DOD-P-24648.	75-64
075-3.4.3.5	Metallic-Ceramic Coated Fasteners.	75-66
075-3.5	HIGH-TEMPERATURE FASTENERS	75-66
075-3.6	SUITABLE USES FOR THREADED FASTENERS	75-67
075-3.7	TELEPHONE NUMBERS AND POINTS OF CONTACT	75-69
075-3.7.1	NAVSEA.	75-69
075-3.7.2	DISC.	75-69
075-3.7.3	NAVICP-M-P (NAVAL INVENTORY CONTROL POINT), FORMERLY SPCC (SHIPS PARTS CONTROL CENTER).	75-69
SECTION 4.	FASTENER TIGHTENING	75-71
075-4.1	GENERAL	75-71
075-4.2	TIGHTENING SEQUENCE	75-72
075-4.3	PRELOAD	75-72

TABLE OF CONTENTS - Continued

Chapter/Paragraph	Page
075-4.3.1 PRELOAD THEORY.	75-72
075-4.3.2 PURPOSE OF PRELOAD.	75-72
075-4.3.2.1 Preventing Loosening.	75-73
075-4.3.2.2 Improving Fastener Fatigue Life.	75-73
075-4.3.3 DETERMINING PROPER PRELOAD.	75-74
075-4.3.3.1 Determining Design Operating Loads.	75-77
075-4.3.3.2 Determining Torque Requirements.	75-77
075-4.4 RELAXATION	75-77
075-4.4.1 General.	75-77
075-4.4.2 INITIAL RELAXATION.	75-77
075-4.4.3 TORSIONAL RELAXATION.	75-78
075-4.4.4 LONG TERM RELAXATION.	75-78
075-4.4.4.1 Stress Relaxation.	75-78
075-4.4.4.2 Vibration Relaxation.	75-78
075-4.5 Methods of establishing preload	75-78
075-4.5.1 TORQUE CONTROL.	75-79
075-4.5.1.1 Units of Measurement.	75-79
075-4.5.1.2 Determining Required Torque.	75-79
075-4.5.1.3 Applying Torque to a Fastener.	75-81
075-4.5.1.4 Torque Wrenches.	75-81
075-4.5.1.5 Tightening Fasteners Using Torque Control.	75-81
075-4.5.1.6 Special Requirements for Spiral-Wound Gaskets.	75-82
075-4.5.1.7 Changes in Torque as Fastener Yields.	75-82
075-4.5.2 TURN-OFF-NUT CONTROL.	75-82
075-4.5.2.1 The Basis of Turn Requirements.	75-82
075-4.5.2.2 Units of Measurement.	75-83
075-4.5.2.3 Initial Snugging.	75-83
075-4.5.2.4 Where to Make the Measurements.	75-84
075-4.5.2.5 Turning the Nut.	75-84
075-4.5.3 STRETCH CONTROL.	75-84
075-4.5.3.1 Determining Stretch Requirements.	75-84
075-4.5.3.2 Measuring the Stretch.	75-84
075-4.5.4 ULTRASONIC STRETCH OR STRESS CONTROL.	75-85
075-4.5.5 HYDRAULIC TENSIONING AND HEATING.	75-85
075-4.6 THREAD LUBRICANTS	75-85
075-4.6.1 GENERAL.	75-85
075-4.6.2 THREAD LUBRICANT APPLICATION.	75-85
SECTION 5. THREADED FASTENER LOCKING	75-91
075-5.1 GENERAL	75-91
075-5.1.1 THREADED FASTENER LOOSENING.	75-91
075-5.1.2 VIBRATION.	75-91
075-5.1.3 LOAD CYCLING.	75-91

TABLE OF CONTENTS - Continued

Chapter/Paragraph	Page
075-5.2 PRELOAD METHOD	75-91
075-5.3 PREVAILING TORQUE (SELF-LOCKING NUT) METHOD	75-92
075-5.3.1 GENERAL.	75-92
075-5.3.2 REUSABLE SELF-LOCKING FASTENERS.	75-92
075-5.3.2.1 Plastic Ring and Insert Fasteners.	75-92
075-5.3.2.2 Reusable Metal (Spring Beam) Self-Locking Nuts.	75-94
075-5.3.3 NONREUSABLE SELF-LOCKING FASTENERS.	75-95
075-5.3.3.1 Distorted Collar Nuts.	75-95
075-5.3.3.2 Distorted Thread Nuts.	75-96
075-5.3.4 JAM NUTS (LOCK NUTS).	75-96
075-5.3.4.1 Jam Nut Assembly.	75-96
075-5.3.4.2 Tightening the Jam Nut.	75-96
075-5.3.5 SETSCREWS.	75-96
075-5.4 MECHANICAL METHOD	75-97
075-5.4.1 GENERAL.	75-97
075-5.4.2 PINS.	75-98
075-5.4.2.1 Cotter Pins.	75-98
075-5.4.2.2 Driven Pins.	75-99
075-5.4.2.3 Use of Hardened Drive Pins.	75-99
075-5.4.2.4 Installing Straight Pins.	75-100
075-5.4.2.5 Installing Taper Pins.	75-100
075-5.4.2.6 Aligning Holes for Pins.	75-100
075-5.4.2.7 Substitutions for Pin-Type Locking Devices.	75-100
075-5.4.3 TAB LOCKS.	75-100
075-5.4.3.1 Installing Tab Locks.	75-101
075-5.4.3.2 Tab Bend Radius.	75-101
075-5.4.4 STAKING AND PEENING.	75-101
075-5.4.4.1 Staking.	75-101
075-5.4.4.2 Peening.	75-101
075-5.5 SAFETY WIRE METHOD	75-101
075-5.5.1 GENERAL.	75-101
075-5.5.2 REWIRING.	75-102
075-5.5.3 TIGHTENING SAFETY WIRED FASTENERS.	75-102
075-5.5.4 WIRE INSTALLATION.	75-102
075-5.6 LOCKWASHER METHOD	75-102
075-5.6.1 GENERAL.	75-102
075-5.6.2 HELICAL SPRING LOCKWASHERS.	75-102
075-5.6.3 CURVED OR CONICAL SPRING LOCKWASHERS.	75-102
075-5.6.4 TOOTHED LOCKWASHERS.	75-103
075-5.6.4.1 Internal Tooth Lockwashers.	75-103
075-5.6.4.2 External Tooth Lockwashers.	75-103
075-5.6.4.3 Internal-External Tooth Lockwashers.	75-105
075-5.6.5 PART NUMBERS.	75-105

TABLE OF CONTENTS - Continued

Chapter/Paragraph	Page
075-5.7 CHEMICAL METHOD	75-105
075-5.7.1 GENERAL.	75-105
075-5.7.2 ANAEROBIC THREADLOCKING COMPOUND.	75-106
075-5.7.2.1 Material Compatibility.	75-106
075-5.7.2.2 Cleaning and Surface Activation Requirements.	75-106
075-5.7.2.3 Anaerobic Compound Cure Time.	75-107
075-5.7.2.4 Fastener Material Curing Characteristics.	75-107
075-5.7.2.5 Primers (Activators).	75-107
075-5.7.2.6 Assembly Time Requirements.	75-107
075-5.7.2.7 Using Heat to Cure.	75-107
075-5.7.2.8 Tightening Chemically Locked Fasteners.	75-107
075-5.7.2.9 Tightening of Studs Set with Chemicals.	75-109
075-5.7.2.10 Threadlocking Compound Selection.	75-109
 SECTION 6. THREADED FASTENER REMOVAL	 75-112
075-6.1 GENERAL	75-112
075-6.1.1 CONTROL.	75-112
075-6.1.2 LEFT-HAND THREADS.	75-112
075-6.1.3 AVOIDING PROBLEMS.	75-113
075-6.1.3.1 Plan Your Job.	75-113
075-6.1.3.2 Think Safety.	75-113
075-6.1.3.3 Stubborn or Damaged Fasteners.	75-113
075-6.1.4 NORMAL REMOVAL.	75-113
075-6.1.5 REMOVAL OF CHEMICALLY LOCKED FASTENERS.	75-114
075-6.1.5.1 Using Torque to Loosen.	75-114
075-6.1.5.2 Using Heat and Torque to Loosen.	75-114
075-6.1.5.3 Using Chemicals and Torque to Loosen.	75-114
075-6.1.5.4 Nonanaerobic Locking Compounds.	75-114
 SECTION 7. INSTALLATION OF THREADED FASTENERS	 75-114
075-7.1 GENERAL	75-114
075-7.2 FASTENER SELECTION PROCEDURE	75-115
075-7.3 FIVE BASIC SITUATIONS	75-115
075-7.3.1 GENERAL.	75-115
075-7.3.2 NEW EQUIPMENT.	75-115
075-7.3.3 DAMAGED FASTENERS.	75-116
075-7.3.4 UNREPAIRABLE FASTENERS.	75-116
075-7.3.5 UNIDENTIFIABLE FASTENERS.	75-116
075-7.3.6 USE OF TEMPORARY FASTENERS.	75-116
075-7.4 SELECTION OF PROPER THREADED FASTENER SYSTEMS	75-116
075-7.4.1 THREADED FASTENER SYSTEM.	75-116
075-7.4.2 TECHNICAL MANUALS AND SYSTEM DRAWINGS.	75-117

TABLE OF CONTENTS - Continued

Chapter/Paragraph	Page
075-7.13.1 GENERAL.	75-125
075-7.13.2 STANDARDS FOR PLAIN HEXAGON NUTS WITH THE SAME PART NUMBER FOR DOUBLE CHAMFERED AND WASHER FACED CONFIGURATIONS.	75-125
SECTION 8. THREADED FASTENER INSPECTION AND REPAIR	75-126
075-8.1 GENERAL	75-126
075-8.2 INSPECTION OF INSTALLED THREADED FASTENERS AND JOINTS	75-126
075-8.2.1 GENERAL INSPECTION.	75-126
075-8.2.2 RUST AND CORROSION.	75-127
075-8.2.3 THREAD PROTRUSION.	75-127
075-8.2.4 TAB WASHERS.	75-127
075-8.2.5 CHECKING PRELOAD.	75-127
075-8.3 VISUAL EXAMINATION OF FASTENERS PRIOR TO INSTALLATION	75-128
075-8.3.1 INSPECTING FOR PROPER APPLICATION TYPE.	75-128
075-8.3.2 HEAD DAMAGE.	75-128
075-8.3.3 RUST OR CORROSION DAMAGE.	75-128
075-8.3.4 OVERTIGHTENED (YIELDED) FASTENERS.	75-128
075-8.3.5 THREAD FLATTENING.	75-128
075-8.3.6 SELF-LOCKING ELEMENTS.	75-128
075-8.4 ADDITIONAL EXAMINATIONS	75-128
075-8.4.1 GALLING.	75-128
075-8.4.2 CHECKING SELF-LOCKING NUTS.	75-128
075-8.5 THREAD REPAIR	75-129
075-8.5.1 GENERAL.	75-129
075-8.5.2 THREAD REWORK.	75-129
075-8.5.3 THREAD FILING.	75-129
075-8.5.4 THREAD LAPPING.	75-129
075-8.6 REWORKING OF THREADED FASTENER JOINTS	75-129
075-8.6.1 FASTENER REMOVAL.	75-129
075-8.6.2 SUBMARINE FASTENER APPLICATIONS.	75-129
075-8.6.3 REWORK/REPLACEMENT OF CLASS 5 INTERFERENCE FIT THREADS.	75-130
075-8.6.3.1 Replacements Using Anaerobic Compounds.	75-130
075-8.6.3.2 Replacement Interference Fit Studs.	75-130
075-8.6.4 REMOVAL AND REUSE OF ASSEMBLED STUDS.	75-131
075-8.6.5 STEPPED STUDS.	75-131
SECTION 9. REMOVING DAMAGED OR STUBBORN THREADED FASTENERS	75-131
075-9.1 GENERAL	75-131

LIST OF TABLES

Table	Title	Page
075-1-1	COMPANION INDUSTRY STANDARDS	75-3
075-1-2	GLOSSARY OF TERMS	75-4
075-2-1	AUTHORIZED MATERIAL SUBSTITUTIONS FOR FASTENERS	75-11
075-2-2	INTERNAL WRENCHING BOLTS/SOCKET-HEAD CAPSCREWS, SELF-LOCKING OR DRILLED FOR SAFETY WIRING	75-16
075-2-3	NAS 1351 AND NAS 1352 PART NUMBERING SYSTEMS	75-19
075-2-4	SOCKET HEAD CAP SCREW MATERIAL IDENTIFICATION	75-21
075-2-5	FF-S-85 HEXAGON-HEAD CAPSCREWS	75-24
075-2-6	PART NUMBERS FOR COMMONLY USED ROUND WASHERS	75-26
075-2-7	NAS 1149 PART NUMBERING SYSTEM FOR ROUND WASHERS	75-29
075-2-8	ZINC-PLATED STEEL NUTS	75-29
075-2-9	ZINC-PLATED STEEL WASHERS	75-31
075-3-2	ASTM F 593 STAINLESS STEEL BOLTS, SCREWS AND STUDS	75-59
075-3-3	STRENGTH AND IDENTIFICATION MARKINGS FOR 400 SERIES STAINLESS STEEL FASTENERS	75-60
075-3-4	SOURCES FOR MIL-S-1222 FASTENER PART NUMBERS	75-61
075-3-5	REPLACEMENTS FOR BLACK OXIDE COATED THREADED FASTENERS (BRASS HEXAGON NUTS)	75-65
075-3-6	ALTERNATIVES TO METALLIC CERAMIC COATED FASTENERS	75-68
075-3-7	INQUIRY AND TECHNICAL RESPONSE RECORD	75-70
075-3-8	NAVSEA CONTACTS	75-71
075-3-9	FEDERAL SUPPLY CODES FOR FASTENERS	75-71
075-4-1	MAXIMUM RECOMMENDED TORQUE VALUES	75-75
075-4-2	TORQUE LIMITS FOR FASTENERS SCREWED INTO LOW SHEAR STRENGTH MATERIAL	75-77
075-4-3	THREAD LUBRICANTS	75-88
075-4-4	THREAD LUBRICANT NATIONAL STOCK NUMBERS	75-90
075-5-1	PLASTIC RING AND INSERT FASTENER BREAKAWAY TORQUE	75-93
075-5-2	LOCKWASHER STANDARDS	75-106

LIST OF TABLES - Continued

Table	Title	Page
075-5-3	LISTING OF ANAEROBIC COMPOUND TO MIL-S-46163	75-108
075-5-4	COMMON ACTIVE AND INACTIVE SURFACES	75-109
075-5-5	LISTING OF PRIMERS (ACTIVATORS) TO MIL-22473	75-109
075-5-6	PROOF TORQUE VALUES FOR FASTENERS INSTALLED WITH ANAEROBIC COMPOUND	75-111
075-7-1	REQUIRED DEPTH OF ENGAGEMENT FOR TAPPED HOLES	75-118

LIST OF ILLUSTRATIONS

Figure	Title	Page
	Certificaton Sheet	0-2
075-2-1	Uniform Strength Fasteners	75-33
075-3-1	FASTENER MATERIAL CHARACTERISTICS (CHEMICAL AND PHYSICAL), IDENTIFICATION MARKINGS AND SUGGESTED USE	75-40
075-3-1	FASTENER MATERIAL CHARACTERISTICS (CHEMICAL AND PHYSICAL), IDENTIFICATION MARKINGS AND SUGGESTED USE (cont.)	75-41
075-3-1	FASTENER MATERIAL CHARACTERISTICS (CHEMICAL AND PHYSICAL), IDENTIFICATION MARKINGS AND SUGGESTED USE (cont.)	75-42
075-3-1	FASTENER MATERIAL CHARACTERISTICS (CHEMICAL AND PHYSICAL), IDENTIFICATION MARKINGS AND SUGGESTED USE (cont.)	75-43
075-3-1	FASTENER MATERIAL CHARACTERISTICS (CHEMICAL AND PHYSICAL), IDENTIFICATION MARKINGS AND SUGGESTED USE (cont.)	75-44
075-3-1	FASTENER MATERIAL CHARACTERISTICS (CHEMICAL AND PHYSICAL), IDENTIFICATION MARKINGS AND SUGGESTED USE (cont.)	75-45
075-3-1	FASTENER MATERIAL CHARACTERISTICS (CHEMICAL AND PHYSICAL), IDENTIFICATION MARKINGS AND SUGGESTED USE (cont.)	75-46
075-3-1	FASTENER MATERIAL CHARACTERISTICS (CHEMICAL AND PHYSICAL), IDENTIFICATION MARKINGS AND SUGGESTED USE (cont.)	75-47
075-3-1	FASTENER MATERIAL CHARACTERISTICS (CHEMICAL AND PHYSICAL), IDENTIFICATION MARKINGS AND SUGGESTED USE (cont.)	75-48
075-3-1	FASTENER MATERIAL CHARACTERISTICS (CHEMICAL AND PHYSICAL), IDENTIFICATION MARKINGS AND SUGGESTED USE (cont.)	75-49
075-3-1	FASTENER MATERIAL CHARACTERISTICS (CHEMICAL AND PHYSICAL), IDENTIFICATION MARKINGS AND SUGGESTED USE (cont.)	75-50
075-3-1	FASTENER MATERIAL CHARACTERISTICS (CHEMICAL AND PHYSICAL), IDENTIFICATION MARKINGS AND SUGGESTED USE (cont.)	75-51
075-3-1	FASTENER MATERIAL CHARACTERISTICS (CHEMICAL AND PHYSICAL), IDENTIFICATION MARKINGS AND SUGGESTED USE (cont.)	75-52
075-3-1	FASTENER MATERIAL CHARACTERISTICS (CHEMICAL AND PHYSICAL), IDENTIFICATION MARKINGS AND SUGGESTED USE (cont.)	75-53
075-3-1	FASTENER MATERIAL CHARACTERISTICS (CHEMICAL AND PHYSICAL), IDENTIFICATION MARKINGS AND SUGGESTED USE (cont.)	75-54
075-3-1	FASTENER MATERIAL CHARACTERISTICS (CHEMICAL AND PHYSICAL), IDENTIFICATION MARKINGS AND SUGGESTED USE (cont.)	75-55

LIST OF ILLUSTRATIONS - Continued

Figure	Title	Page
075-3-1	FASTENER MATERIAL CHARACTERISTICS (CHEMICAL AND PHYSICAL), IDENTIFICATION MARKINGS AND SUGGESTED USE (cont.)	75-56
075-3-1	FASTENER MATERIAL CHARACTERISTICS (CHEMICAL AND PHYSICAL), IDENTIFICATION MARKINGS AND SUGGESTED USE (cont.)	75-57
075-3-1	FASTENER MATERIAL CHARACTERISTICS (CHEMICAL AND PHYSICAL), IDENTIFICATION MARKINGS AND SUGGESTED USE (cont.)	75-58
075-4-1	Tightening Sequence	75-72
Figure 075-4-2	Measuring the Stretch	75-86
075-5-1	Plastic Ring Nut	75-94
075-5-2	Types of Self-Locking Bolts	75-95
075-5-3	Spring Beam Nut	75-95
075-5-4	Distorted Collar Nuts	75-96
075-5-5	Jam Nut Assembly	75-97
075-5-6	Setscrews	75-97
075-5-7	Cotter Pin	75-98
075-5-8	Types of Drive Pins	75-99
075-5-9	Tab Locks	75-101
075-5-10	Safety Wiring Examples	75-104
075-5-11	Helical Spring Lockwasher	75-105
075-5-12	Curved or Conical Lockwasher	75-105
075-5-13	Toothed Lockwashers	75-105
075-7-1	Types of Bolts	75-121
075-7-2	Types of Bolt Studs	75-123
075-7-3	Nut Configurations	75-126
075-9-1	Broken Stud Drill Guide Removal Device	75-135
075-9-2	Broken Bolt Extractor	75-135

CHAPTER 75

FASTENERS

SECTION 1.

INTRODUCTION TO THREADED FASTENERS

075-1.1 SCOPE

075-1.1.1 GENERAL. This chapter covers the use and installation of threaded fasteners to repair and maintain shipboard equipment. The selection of proper threaded and locking methods shall be found in applicable parts lists, drawings or technical manuals. The design and selection of threaded fasteners for specific applications is beyond the scope of this chapter; however, references to design and selection procedures are provided. Guidelines for selecting and tightening fasteners are also provided. The guidance in this manual may be used when specific information is unavailable or when emergency repairs are required.

075-1.1.1.1 Many nonthreaded mechanical fasteners such as rivets, bands, lock rings, and clamps are not included in this document.

075-1.1.1.2 Unless otherwise stated, all threaded fasteners discussed in this document have right-handed threads; that is, they tighten (advance) when turned to the right (clockwise).

075-1.1.1.3 The information in this manual covers the following:

- a. Identifying fasteners by their markings.
- b. How to distinguish between different types of similar fasteners.
- c. Properly using thread inserts.
- d. Identifying threaded fasteners by their markings, and by their thread class, fit, series, and designation.
- e. Proper thread lubricants.
- f. Proper tightening requirements and recommended torque limits for fastener tightening. This manual also includes guidelines for calculating fastener torque requirements when they are unavailable.
- g. Thread fastener locking using self-locking fasteners and applying chemical thread-locking compounds.
- h. Selecting a suitable fastener system when the equipment specifications or the original fasteners or both are unavailable.
- i. Inspecting fasteners to see if they are suitable for reinstalling and inspecting installed fasteners.
- j. Repairing damaged fasteners.
- k. Removing stubborn or damaged fasteners.

075-1.1.2 REFERENCE DOCUMENTS. To assist in developing Controlled Work Packages and to have a direct reference to the chemical and physical properties of fasteners as well as their specific manufacturing requirements, the following documents will be of assistance:

- a. NAVSEA 0948-045-7010, Material Control Standard (Non-Nuclear) Volumes 1 and 2.
- b. NAVSEA 0948-LP-103-6010, Catalog of Level I/Subsafe Components.
- c. NAVSEA S9085-AM-GYD-010, Submarine Fastening Criteria (Non-nuclear). This contains additional information on design and maintenance techniques associated with submarine fasteners in pressure vessels and piping. Although not specified for surface ships, it contains helpful technical data.
- d. FED-STD-H28, **Screw Thread Standards for Federal Services**. (NOTE : Many of the FED-STD-H28 slash sheets reference ASME/ANSI (American Society of Mechanical Engineers/American National Standards Institute) documents. Companion industry standards to FED-STD-H28 are included in [Table 075-1-1](#).)
- e. VHS video tape titled **Fastener Selection and Installation (PIN 805737)**. This VHS format video tape provides information on how to identify and order replacement fasteners along with information on the procedures to be followed when installing fasteners.

075-1.2 GENERAL

075-1.2.1 USING FASTENERS. At first glance nuts and bolts may appear to be simple devices. It is true that they are not complex mechanisms. If you consider the jobs they are required to do, however, they are very sophisticated devices, especially when you realize that a single 1/4-inch, SAE Grade 8 bolt and nut can hold up a full-size car (if the fixture through which the bolt passes also can support the required load). A 1/4-20 UNC 3A, SAE Grade 8 bolt has a tensile stress area of 0.0318 square inch with a proof load capacity of 120,000 pounds per square inch. This gives the bolt an axial load capacity of 3,816 pounds, the approximate weight of a car.

075-1.2.1.1 The point of all this is that the 1/4-inch bolt will hold up the car only if the proper thread class and material grade are selected and the bolt is installed properly. For example:

- a. The material strength and thickness of the nut has to be able to develop the full strength of the bolt.
- b. The nut has to be screwed on the bolt so that all the threads in the nut are fully engaged. If the bolt is screwed into a tapped hole, instead of using a nut, the hole should be tapped deep enough to develop the full strength of the bolt.
- c. The bolt holes in the fixture that is bolted to the car have to be the proper size and drilled square with the nut and bolt bearing surfaces to prevent putting a bending load on the bolt head.
- d. If you expect to hold up the car for any length of time, you have to select a fastener with the proper coating to prevent corrosion.
- e. Grade 8 bolts are sensitive to hydrogen, which causes hydrogen embrittlement. You have to be careful, therefore, about what corrosion protection coating you use in what environment: in certain environments some coatings will release atomic hydrogen into the fastener.
- f. A Grade 8 bolt gets a significant part of its strength from heat treating. If you try to weld it to something, the bolt may be weakened and fail.
- g. If you expect to pick up the car very often, you will be unable to loosen the bolt and retighten it each time, and you will have to design the bolt fixture so that the bolt can be properly preloaded to protect it from fatigue failure.
- h. Additionally, you should always add a safety factor to the calculated design stress to ensure that the fastener will not fail in service.

Of course, no one would use a 1/4-inch bolt and nut to pick up a car. This example just shows you the things to consider when you select a fastener to do a job. This manual is designed to make you, the user, aware of some of these considerations and the pitfalls or consequences of choosing the wrong fastener.

Table 075-1-1 COMPANION INDUSTRY STANDARDS

Area Covered	FED-STD-H28 Document No.	ASME/ANSI Companion Standard
Nomenclature, Definitions, and Letter Symbols for Screw Threads	FED-STD-H28/1	ASME/ANSI B1.7M
Unified Inch Screw Threads - UN and UNR Thread Forms	FED-STD-H28/2	ASME B1.1
Controlled Radius Root Screw Threads, UNJ Symbol	FED-STD-H28/4	ASME B1.15
Unified Miniature Screw Threads	FED-STD-H28/5	ANSI B1.10
Gauges and Gauging for Unified Screw Threads - UN and UNR Thread Forms	FED-STD-H28/6	ASME/ANSI B1.2
Inspection Methods for Acceptability of UN, UNR, UNJ, M, and MJ Screw Threads	FED-STD-H28/20	ASME/ANSI B1.3M
Metric Screw Threads	FED-STD-H28/21	ASME/ANSI B1.13M and ANSI B1.21M
Metric Screw-Thread Gauges	FED-STD-H28/22	ASME/ANSI B1.16M, B1.21M
Class 5 Interference-Fit Screw Threads	FED-STD-H28/23	ASME/ANSI B1.12

075-1.2.1.2 Threaded fasteners are used throughout a ship to join individual parts of machinery, piping, and equipment mechanically. Because of this extensive use, threaded fasteners come in a wide variety of types, sizes, and materials. This great variety of fasteners, when combined with the special design requirements of shipboard equipment, requires you to be careful when using, maintaining, and replacing them.

075-1.2.2 FASTENER MAINTENANCE PRACTICES. Many shipboard machinery and equipment casualties have been caused by improperly maintaining or installing threaded fasteners. The three main causes are substituting a lower strength fastener, failing to use corrosion-resistant fasteners in corrosive environments, and improperly preloading. Proper strength and proper preload are especially important when high-impact (HI) shock requirements need to be considered. A fastener may be entirely satisfactory for normal operating loads yet fail when subjected to HI-shock loads during combat.

075-1.2.3 HI SHOCK. HI-shock is the pressure pulse suddenly applied to a ship by a noncontacting underwater explosion. This pressure pulse has a high intensity, and, although less severe than the shock pulse caused by the direct impact of a projectile, it is sensed by personnel as a high-intensity shock pulse; hence the term "HI-shock."

075-1.2.3.1 A significant difference in the two forms of shock that is important to fastener design is that, under HI-shock, the stresses and strains (stretching of the bolt) can be calculated by conventional means using normal physical properties. The speed with which the shock load is applied and the resulting speed at which the fastener is stretched (strain rate) is lower than for direct impact of a projectile. The resulting strain rates are low enough so that the mechanical properties of a fastener, such as the modulus of elasticity and the yield and tensile strength, do not increase significantly. Under direct impact shock loads, however, the strain rate is high enough to cause these properties to increase significantly, requiring more elaborate calculations.

075-1.2.3.2 All shipboard equipment, systems, and components are assigned one of three HI-shock grades. Grade A shock is assigned to items that must remain fully functional during and after the application of HI-shock loads. Grade B shock is assigned to items that do not have to remain functional but are not allowed to present a hazard to personnel at assigned battle stations or to Grade A shock items. Essentially, Grade B items shall not come adrift or rupture their pressure boundary. Grade C shock is assigned to the remaining shipboard items, which, either by their basic design or their location, do not present a hazard.

075-1.2.3.3 Because of shock qualification requirements, substitution of fasteners of different designs or materials should not be made on equipment subject to Shock Grade A or Shock Grade B requirements without engineering analysis and approval.

075-1.2.4 GLOSSARY OF TERMS. Be careful when using common names or slang terms. The fastener world has become more complicated. Terms that were acceptable, such as Cr-Mo, may now be ambiguous. ASTM A 193 Grade B7 bolts are in fact bolts made from a steel alloy containing chromium and molybdenum, whereas ASTM A193 Grade B16 bolts are bolts made from a steel alloy containing chromium, molybdenum, and vanadium. When someone uses the term Cr-Mo, it is very difficult to know which of the two steel alloys they are referring to. [Table 075-1-2](#) is an alphabetical listing of terms used in this chapter.

Table 075-1-2 GLOSSARY OF TERMS

Term	Definition
AARH	Arithmetic average roughness height (Ra), is the arithmetic average of the height of the grooves or serrations in the flange of a bolted joint measured from the nominal or ideal surface to the peaks of the serrations, not peak to valley.
allowance	Minimum clearance (positive allowance) or maximum interference (negative allowance) between mating parts.
alloy steel	Steel containing significant quantities of alloying elements (other than carbon and the commonly accepted amounts of manganese, silicon, sulfur, and phosphorus) added to obtain specific mechanical or physical properties, such as toughness, strength at elevated temperatures, and corrosion-resistance.
anaerobic thread-locking compound	A liquid that solidifies in the absence of air; used to secure threaded fasteners against loosening in service.
bearing face or surface	The surface that is at right angles to the fastener centerline and that bears against the part or parts that it fastens; the area under the nut or head of a bolt.
body	The unthreaded portion of the shank of an externally threaded fastener.
body-bound bolt	See fitted bolt.
bolt	A threaded fastener with an integral, usually hexagonal, head on one end intended to be used with a nut. Sometimes incorrectly called a capscrew.
bolt stud	A headless fastener threaded with the same form and fit of thread on both ends or continuously threaded throughout its length. Generally used with a nut on each end.
bottoming	Screwing a capscrew or stud into a tapped hole until it contacts the bottom of the hole.
capscrew	A threaded fastener with an integral, usually hexagonal, head on one end that is intended for use in a tapped hole. It has stringent controls on its dimensions so that it can be more easily screwed into a tapped hole.
clamping force	The force, created by tightening a threaded fastener.
class of thread	An alphanumerical (letter and number combination) designation to indicate the standard grade of tolerance and allowance specified for a thread.
clearance fit	A fit between mating, assembled parts that provides a clearance at their maximum material condition. (See "fit").

Table 075-1-2 GLOSSARY OF TERMS - Continued

Term	Definition
cold heading	A room temperature metal forging process using high forces to form a head on bolts and screws.
extensometer	An instrument used for measuring the extension or stretch of a bolt or stud, such as a micrometer.
fastener	A mechanical device that holds two or more main bodies in definite positions with respect to each other.
fit	A term used to describe the looseness or tightness of two mating parts such as Class I fit (loose), Class 3 fit (tight), Class 5 fit (interference), thumb press fit (snug).
fitted bolt	A stud or bolt that has been fitted to its mating hole so that the clearances between its unthreaded shank and its mating hole are extremely small. Either the hole is drilled and reamed true and square with the bearing surface and the bolt machined to fit the hole, or the bolt is premachined and the hole reamed to fit the bolt. Not to be confused with interference fit.
functional pitch diameter	The pitch diameter of an enveloping thread with perfect pitch, lead, and flank angles and having a specified length of engagement. This diameter includes the cumulative effect of variations in lead (pitch), flank angle, taper, straightness, and roundness. Variations at the thread crest and root are excluded.
galling	A condition on any of the rubbing surfaces of one or both mating parts where friction between microscopic high spots causes localized welding, resulting in spalling, further roughening of the surface, followed by more severe localized welding.
grip length	The distance from the underside of the head to the end of the full cylindrical portion of the shank including transition threads. It is the nominal screw length minus the basic thread length.
interference fit	A fit between mating assembled parts that provides an interference at their minimum material condition.
internal wrenching bolt	A bolt having a large conical head with a flat top, flat bearing surface, and hexagon socket.
ksi	Abbreviation for 1,000 pounds per square inch, the k representing 1,000.
length of thread engagement	The axial distance over which the complete external thread is in contact with the complete internal thread, measured at the pitch diameter.
machined threads	Threads that are formed by cutting away material.
major diameter	On a straight thread, the major diameter is the diameter of the crest of the external thread or the root of the internal thread. For a taper thread, the major diameter is the diameter of the crest of the external thread or the root of the internal thread measured at any given point along the thread.
maximum material condition	The condition where the crest and root of an externally threaded fastener are at their maximum diameter or the crest and root of an internally threaded fastener are at their minimum diameter.
minimum material condition	The condition where the crest and root of an externally threaded fastener are at their minimum diameter or the crest and root of an internally threaded fastener are at their maximum diameter.
minor diameter	On a straight thread, the minor diameter is the diameter of the root of the external thread or the crest of the internal thread. For a taper thread, the minor diameter is the diameter of the root of the external thread or the crest of the internal thread measured at any given point along the thread.
peening	Peening is the forging (peening) of the end of a pin or bolt to expand it. In the case of bolt or stud, it prevents the nut from coming off.

Table 075-1-2 GLOSSARY OF TERMS - Continued

Term	Definition
pitch	The distance, measured parallel to the fasteners axis, between corresponding points on adjacent thread forms in the same axial plane and on the same side of the axis. Usually given in threads per inch.
pitch diameter	The diameter of an imaginary cylinder whose surface passes through the threads at the point where the width of the thread groove is the same as the width of the thread ridge, roughly half way between the top and bottom of the thread.
preload	The amount of clamping force exerted by a fastener on joined members solely due to tightening the fastener.
prestress	The axial stress in the fastener that results solely from the preload.
prevailing torque	The torque required to rotate a nut or bolt where the fastener is applying no clamping force to the parts being fastened. The torque required to bring mating parts together is not considered prevailing torque.
prevailing torque locknut	A locknut that maintains a prevailing torque or resistance to rotation even with no clamping force present.
proof load	Proof load is a specified test load that a fastener must withstand without indicating any yielding or permanent deformation.
roll-pin	A straight pin made of a tubular section of hardened spring steel slit lengthwise down one side. The pin compresses when driven into a slightly smaller hole and its spring properties retain it in place.
root diameter	The diameter of an imaginary cylinder or cone bounding the bottom of the roots of a screw thread. Root diameter is the more common term for the minor diameter of an external thread or the major diameter of an internal thread.
roll-formed threads	Threads formed by forging a smooth rod between rotating or reciprocating dies.
self-locking threaded fastener	A fastener having a self-contained locking feature, such as an elastic stop nut or a distorted thread nut, that resists rotation by gripping the mating thread and does not depend upon the bolt, nut, or stud load for locking.
shouldering	Shouldering occurs when the thread runout at the beginning of the unthreaded shank enters the threaded hole, causing local distortion of the threads and surrounding area.
slugging	A procedure for tightening large fasteners by striking a special wrench, called a slugging wrench, that has a large flat striking surface on the end of its short handle.
socket head capscrew	A headed, externally threaded fastener with a recessed, hexagonal socket for a hex (allen) wrench.
spalling	The breaking or chipping off of material, usually by impact forces.
spiral-pin	A straight pin made of a rolled-up strip of hardened spring steel that looks like a clock spring or spiral in cross section. The pin compresses when driven into a slightly smaller hole and its spring properties retain it in place.
spring-pin	See Roll-Pin and Spiral-Pin.
staking	The upsetting of the surrounding metal at three or four points with a center punch at the head or at the point, if it is exposed, to secure the fastener.
stud	A headless fastener threaded on each end or continuously threaded over its entire length. It is intended to be set into a tapped hole either by using a class 5 (interference) fit on the set end or by using an anaerobic threadlocking compound. A stud may have different fits on the set and nut ends.
tensile strength	The maximum tensile stress (in pounds per square inch) a material can sustain without tearing apart. Also referred to as ultimate strength.
tensile stress area	The circular cross-sectional area of a theoretical unthreaded rod whose cross-sectional area is such that it would fail in tension at the same load as a particular threaded fastener.

Table 075-1-2 GLOSSARY OF TERMS - Continued

Term	Definition
thread gauges	Gauges used to check threads for conformance with specifications, such as thread indicating gauge, thread limit gauge, thread plug gauge, thread ring gauge, thread snap gauge, or go no-go gages.
thread gauging	Using a thread gauge to determine whether a fastener is within specified limits.
through bolt	A bolt that passes completely through both members to be fastened and has a head on one end and a nut on the other. (See bolt)
tolerance(s)	Tolerances are specified amounts by which dimensions are permitted to vary. The tolerance is the difference between the maximum and the minimum limits permitted.
torque	A turning or twisting force exerted on a fastener. Torque is measured in foot-pounds or inch-pounds in U.S. customary units and is equal to the force in pounds applied to the end of a theoretical 1-foot or 1-inch-long wrench handle. Conversion factors from U.S. customary units to metric (SI) are: foot pound-force to newton meter (N • m) 1 lbf • ft = 1.356 N • m inch pound-force to newton meter (N • m) 1 lbf • in = 0.113 N • m
torque, breakaway	The torque required to start the rotation of a fastener. The magnitude of this torque is significant when checking the bonding of an anaerobic locking compound. The term is also used to describe the torque required to start the rotation of a fastener when loosening it or restarting its rotation when tightening a group of fasteners in successive increments. Breakaway torque will always be higher than that required to continue the rotation.
torque, prevailing	See prevailing torque.
ultimate strength	See tensile strength.
washerfaced	A shoulder formed on the bearing surface of a bolt head or nut with a smooth bearing surface and a round outer diameter, designed to eliminate the need for a flat washer.
yield strength	The maximum tensile stress (in pounds per square inch) that a material can sustain without causing more than a specified amount of permanent deformation.

SECTION 2.

IDENTIFICATION OF FASTENERS

075-2.1 GENERAL

075-2.1.1 Threaded fasteners are used in a wide variety of applications. To meet the specific requirements of each application, threaded fasteners are supplied in various materials with different strengths, degrees of corrosion resistance, temperature resistances, and toughness. Replacement fasteners must be carefully selected to ensure that the properties of the new fastener meet or exceed those specified for the application.

075-2.1.2 This section discusses the way in which fasteners are identified and classified by thread class, fit, and series. It also discusses many of the fasteners that are considered as preferred for design and are available from the Federal Supply System. Threaded inserts and nonstandard fasteners are also identified here. The markings used on fasteners to identify the fastener material are covered in [Section 3](#) of this chapter.

075-2.2 THREAD CLASS, FIT, SERIES, AND DESIGNATION

075-2.2.1 THREAD CLASSES. Standard thread classes have been established to control the amount of tolerance and allowance used in forming threads. Compliance with the established tolerances and allowances ensures that threaded components will be interchangeable. There are six classes of clearance fit threads: three for external threads, 1A, 2A, and 3A; and three for internal threads, 1B, 2B, and 3B. Allowance is specified only for classes 1A and 2A, and the allowance is identical for both classes. Tolerance decreases as class number increases. The tolerance for class 3A is less than that for class 2A, which is less than that for class 1A (i.e., the higher the thread class number, the tighter the fit). There are also five classes of interference fit threads: three for external threads, NC5 HF, NC5 CSF, and NC5 ONF; and two for internal threads, NC5 IF and NC5 INF. The different classes of threads are distinguished from each other by the amounts of tolerance and allowance specified.

075-2.2.1.1 Class 1. Class 1A and 1B threads are intended for use where quick and easy assembly is necessary and where a liberal allowance is required to permit ready assembly, even with slightly bruised or dirty threads. They are typically used for such applications as the threaded pins in rigging gear, turn-buckles, and other applications requiring thick zinc coatings. In general, these classes are not in common use on board ship.

075-2.2.1.2 Class 2. Class 2A and 2B threads are the most frequently used thread classes for general shipboard applications. They provide a reasonable degree of strength (being somewhat stronger than class 1) while having enough clearance to permit application of corrosion-resistant coatings.

075-2.2.1.3 Class 3. Class 3A and 3B threads are used in specific applications where closeness of fit and accuracy of lead angle are important, such as for adjusting devices and long thread engagements. They require high-quality production equipment and quality control and provide no allowance for assembly or coatings. Class 3 threads have no clearance at the extreme end of their tolerances and allowances. They are also coming into increased use for studs which are set with anaerobic thread-locking compound, for socket-head capscrews, and for elastic stop nuts, where close fits improve locking performance.

075-2.2.1.4 Class 5. Class 5 threads are interference fit threads and are available in the older NC (National Coarse) series only. They are for use where the set end of a stud needs to be restrained in its tapped hole against loosening in service or loosening when the nut is removed. Studs with a class 5 fit on the set end can have either a class 2 or a class 3 fit on the opposite end, as the application requires. Normally, the class 5 fit for stud set end can be avoided by using a locking compound with a class 2 or class 3 fit (see paragraph [075-5.7.2.10.2](#)).

075-2.2.2 THREAD FIT. The fit of threads describes the predictable amount of clearance between the external and the internal threads in an assembly. The fit of threads is determined by the class of the internal and the external thread. The thread fit ranges from loose, when class 1A and 1B threads are mated, to an actual interference fit, where the external thread pitch diameter (PD) is larger than the internal thread PD with class 5 interference fit threads.

075-2.2.2.1 Class 1, 2, and 3 Fit. Although it is common practice to mate external and internal threads of the same class together, for some applications the requirements for a specific thread fit may be met by specifying an appropriate combination of external and internal thread classes. A class 1A external thread, for example, can be mated with a class 1B, 2B, or 3B internal thread to achieve a variety of thread fits.

075-2.2.2.2 Class 5 Fit. Class 5 fits present problems in installation, removal and repair unless careful sizing and installation procedures are followed. Wherever temperature limits permit, it is better to use class 3A studs with anaerobic thread-locking compound on the set end.

075-2.2.2.2.1 ASME B1.12 and FED-STD-H28/23 define Class 5 threads and their use. ASME B1.12 describes the many different fits used over the years. To standardize thread configurations for logistic support it is recommended that Class NC5-HSF threads per Appendix C of ASME B1.12 be used on studs for all initial installations regardless of the material into which the stud is being installed. The internal threads recommended for Ni-Cu-Al, Titanium and other materials with a hardness over 160 HB are NC5-IHS per Appendix C of ASME B1.12. For both ferrous and non-ferrous materials with a hardness less than 160 HB the use of NC5-INF internal threads per the basic ASME B1.12 are recommended. In repair applications, it may be necessary to use studs providing more interference by using thread forms with a slightly larger major diameter. Guidance on thread interference requirements for repair is discussed in paragraph 075-8.6.3.2.

075-2.2.3 THREAD SERIES. Four unified screw thread series have been established. Each thread series consists of a series of fastener diameters having a particular distribution of thread pitches. Only three of these four series are in general use on board ship. These series are: UNC, the unified coarse thread series; UNF, the unified fine thread series; and UN, the constant pitch thread series. The fourth series is NC, the National Coarse thread series, which is based on the older American National Thread Standard. NC is still used for class NC5 fit studs and their tapped holes.

075-2.2.3.1 UNC (Coarse Thread) Series. The most common series is the UNC, or coarse thread series, which makes up the bulk of all threaded fastener production. With this series, each fastener diameter between 1/4 inch and 1 inch has a different pitch ranging from 20 threads per inch (tpi) for the 1/4-inch size to 8 tpi for the 1-inch size.

075-2.2.3.2 UNF (Fine Thread) Series. For the UNF, or fine thread series, the thread pitch ranges from 28 tpi for the 1/4-inch size to 12 tpi for the 1-inch size. There is some duplication of pitch in the fine thread series; both the 5/16 and the 3/8-inch size, for example, have a pitch of 24 tpi.

075-2.2.3.3 UN (Constant Pitch Thread) Series. The UN, or constant pitch thread series, consists of eight series designated 4UN, 6UN, 8UN, 12UN, 16UN, 20UN, 28UN, and 32UN, each series having a thread pitch equal to the number preceding the UN designation. The eight thread series, 8UN, is the only thread in the constant pitch series in common use for nuts and bolts on board ship. The others are used primarily in pipe unions or special applications.

075-2.2.3.4 UNJ. The UNJ thread form in accordance with MIL-S-8879 or ASME B1.15 is similar to UN Threads except that the root must be rounded, the root radius and minor diameter must be inspected within the limits specified and the specified root radii are larger, thus creating a larger minor diameter. There are UNJC and UNJF threads. UNJ series threads are widely used by manufacturers of self-locking nuts.

075-2.2.3.5 NC (National Coarse Thread) Series. The NC, or National Coarse thread series, has the same pitch as the UNC series, but it is used only for class 5 interference fit threads. (See paragraph 075-2.2.2).

075-2.2.4 THREAD DESIGNATION. Following is an example of a complete thread designation of a 1/2-inch diameter fastener with 13 tpi, unified coarse thread series, with external threads having a Class 3A Fit.

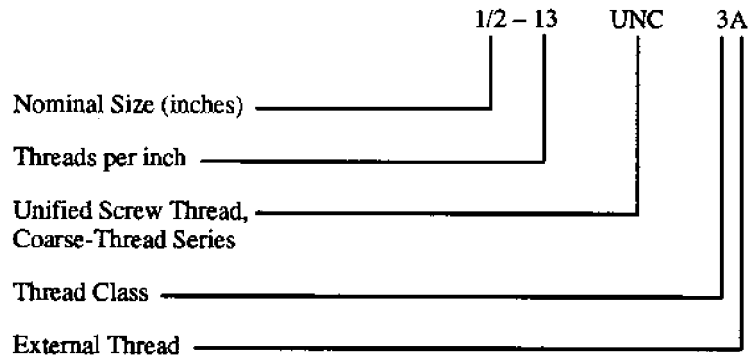

075-2.2.5 **THREAD ACCEPTABILITY, GAUGING.** Two basic concerns are associated with the suitability of a threaded fastener for a particular job: fit and function. Whether a fastener will perform its function depends on its physical properties; hardness, tensile strength, proof load capacity, fatigue resistance, ductility. The fastener's fit determines if the fastener can be installed satisfactorily and if there is enough thread engagement and overlap to be able to develop full load-carrying capacity. Fasteners have to be measured for fit and tested for function. Thread gauging is normally the responsibility of the manufacturer, not the installing activity.

075-2.2.5.1 **Fastener Fit Requirements.** ASME B1.3 provides three different gauging systems for determining the fit of threaded fasteners: system 21, system 22, and system 23. These systems are thread measuring systems and are used to determine if the various dimensions of both external and internal threads are within acceptable limits; that is, will they fit together properly. Within these gauging systems, only the dimensions listed in paragraph 075-2.2.5.1.1 are important to shipboard personnel.

075-2.2.5.1.1 **Significant Thread Characteristics.** Only three dimensions for external threads and two for internal threads are important in determining proper fit. These are: major diameter, functional pitch diameter, and minimum pitch diameter (class 3A only) for external threads; and functional pitch diameter and minor diameter for internal threads.

075-2.2.5.1.2 **Thread Gauging for Repair Actions.** Unless directed by other guidance, system 21 may be used to check major diameter and functional pitch diameter for external threads, and minor diameter and functional pitch diameter for internal threads. System 22 may be used to check minimum pitch diameter for class 3A external threads. Except for interference fit thread applications, System 21 gaging may be used to determine the acceptability of tapped holes and fasteners for installation in repair actions even when the fastener specifications requires inspection in accordance with System 22.

075-2.2.6 **THREAD GAUGES.** The following thread gauges are available to identify the threads on fasteners, and are not the thread gauges used to determine the fit of the thread:

National Stock No.	Description
5219-00-221-1992	27-blades; range 2-1/4 to 28 tpi, Style I, American National. Includes center gauge with coarse and fine notches.
5210-00-293-1872	28-blades; range 4 to 80 tpi, Style B, Sharp V.
5210-00-203-7763	51-blades; range 4 to 84 tpi, Style G, American National.

National Stock No.	Description
5210-00-221-1991	Metric, 28-blade, encased blade type - double blade/group. Sizes .25 to .90 in 5-mm increments: 1.00, 1.10, 1.20, 1.25, 1.30, 1.40, 1.50, 1.60, 1.70, 1.75, 1.80, 1.90, 2.00, and 2.50 mm.

075-2.3 IDENTIFYING REPLACEMENT FASTENERS

Replacement fasteners should be readily identifiable from drawings, technical manuals, and logistic support documentation such as Allowance Parts Lists (APL). Identification has sometimes been difficult because of deficiencies in component drawings and logistical support documentation. Paragraphs 075-2.3.1 and 075-2.3.3 give help to identify the proper replacement fasteners. Use Table 075-2-1 for material substitutions. For reactor plant applications, use the appropriate General Reactor Plant Overhaul and Repair Specification for allowed material substitutions.

075-2.3.1 DRAWING IDENTIFICATION REQUIREMENTS. Detailed system and component drawings should identify the fasteners by a military or industry part number. Many drawings for systems and components do not comply with drawing requirements for part identification. Fastener hardware is often identified only by a military specification or by a proprietary manufacturer's part number, without identifying the applicable military or industry standard part identification number. If the fastener is identified by a military or an industry part number, this number can be crossed-checked directly to a National Stock Number (NSN) if the part is stocked in the system. If the part number is not identified on the system or component drawing, review the APL next. Since APL's are updated more than the drawings, always check the APL's.

Table 075-2-1 AUTHORIZED MATERIAL SUBSTITUTIONS FOR FASTENERS

Old Material - Bolts/Screws/Studs	Replacement Material - Bolts/Screws/Studs
Alloy Steel - ASTM A193 Gr B7	Alloy Steel - ASTM A193 Gr B16
Carbon Steel - SAE J429 Grade 2 or Grade 5 - Uncoated	Alloy Steel - ASTM A193 Gr B16 or ASTM A449 Type 1
Carbon Steel - SAE J429 Grade 2 or Grade 5 - Zinc coated	Carbon Steel - ASTM A449 Zinc electroplated per ASTM B633
Carbon Steel - SAE J429 Gr 8	Alloy Steel - ASTM A 354 Grade BD
Old Material - Nuts and Bolts/Studs/Screws	New Material - Nuts and Bolts/Studs/Screws
Silicon Bronze - ASTM F468 Alloy 655	Nickel-Copper - ASTM F468 Alloy 400 where a magnetic material is acceptable
Naval brass - ASTM F468 Alloys 462, 464	
Bronze (or Copper) ASTM F468 Alloy 110	
Aluminum Bronze - ASTM F468 Alloys 613, 614	Nickel-Copper-Aluminum, QQ-N-286 (Note: Where a slightly lower strength and magnetic material are acceptable, Nickel-Copper Alloy 400 may be used with engineering approval (see paragraph 075-3.7 and Table 075-3-7.)
Manganese Bronze - ASTM F468 Alloy 675	
Phosphor Bronze - ASTM F468 Alloy 510	

**Table 075-2-1 AUTHORIZED MATERIAL SUBSTITUTIONS FOR
FASTENERS - Continued**

Old Material - Bolts/Screws/Studs	Replacement Material - Bolts/Screws/Studs
Silicon Bronze - ASTM F568 Alloys 651 and 661	
Old Material - Nuts	New Material - Nuts
Carbon and Alloy Steel - ASTM A194 Grades 2, 2H, 2HM, 4 SAE J 995 Grades 2 and 5	Carbon and Alloy Steel ASTM A 194, Grade 7
Carbon Steel - SAE J 995 Gr 8	ASTM A 563 Gr D
Nickel-Copper-Aluminum ASTM F467, Alloy 500	Nickel-Copper ASTM F 467 Alloys 400, 405 Heavy Hex Configuration only
Phosphor bronze and silicon bronze, ASTM F467 Alloys 510, 651, and 661	Nickel-Copper ASTM F 467 Alloys 400, 405

075-2.3.2 IDENTIFYING FASTENERS ON APL'S. In the past the general policy was not to include fasteners on APL's unless the fasteners were carried as onboard spares. Since the fasteners are often identified improperly on drawings, however, a policy is being implemented to identify replacement fastener hardware on new APL's, even when the APL authorizes no onboard spares. Some APL's have been revised; others will be revised only when being updated for other reasons or when revision is specifically requested. In identifying fasteners on APL's, the component piece number and manufacturer's part number should be cross referenced for those applications in which the standard part number for the fastener is not identified on the component drawing. Where fastener hardware is identified on APL's, the NSN will be identified in addition to the standard part identification number.

075-2.3.3 IDENTIFYING FASTENERS AND FASTENER STANDARD PART NUMBERS WHEN SUPPORT DOCUMENTATION IS LACKING. When support documentation is inadequate to identify the standard part identification numbers for fastener hardware, the following approach is recommended:

- a. Obtain the following information on the fastener from the component drawing or by inspecting the fastener:
 - 1 Type fastener: Socket head capscrew, hex-head capscrew, machine bolt, stud, stud bolt, setscrew, etc.
 - 2 Fastener threads: number/inch, other identification as to coarse or fine, US or metric. (See paragraph 075-2.2.6 for thread gauges).
 - 3 Material and coating: for example, zinc-plated alloy steel.
 - 4 Dimensions: diameter and length, threaded length
 - 5 Strength: (This information will rarely be available, but sometimes drawings may identify tensile strength or an SAE or ASTM grade)
- b. For those activities that have access to Fastener Preferred for Design Standards, compare the fastener characteristics identified above with those fasteners listed in the applicable Preferred for Design Standard listed below:
 - MIL-STD-1251, **Screws and Bolts, Preferred for Design**
 - MIL-STD-1598, **Studs, Preferred for Design**

MIL-STD-1758, Inserts, Screw Thread, Preferred for Design**MIL-STD-1764, Washers, Preferred for Design****MIL-STD-1903, Nuts, Preferred for Design**

- 1 Each preferred for design standard has a table of contents that identifies fasteners by type and indicates the section of the document in which that type fastener can be found. Each section contains a sketch of the type fastener covered along with applicable standards, material, material strength, protective finish (coating), and some of the more important dimensions. Also listed is the applicable standard part identifying number (dash number).
- 2 Take the following steps to identify a replacement fastener.
 - (a) Identify the type of fastener required.
 - (b) See if the desired material, protective finish (coating), and strength match those required.
 - (c) See if the required diameter and thread size match.
 - (d) Verify that the threaded length of the proposed replacement is adequate (see paragraphs [075-7.5](#) and [075-7.6](#)).
 - (e) Identify the dash number for the proper length. (Most screws and bolts are identified by the MS number and a dash number for length. Sometimes more than one dash number may be required to identify the fastener. Sometimes you will have to refer to the applicable standard to identify the appropriate dash numbers.)
- 3 If a standard part number for the required fastener cannot be located in the Preferred for Design Standard, or the Preferred for Design Standard is unavailable, the next step is to use the Federal Supply Classification to identify the fastener. The Federal Supply Classes for fasteners and related items are:
 - (a) 5305 Screws
 - (b) 5306 Bolts
 - (c) 5307 Studs
 - (d) 5310 Nuts and Washers
 - (e) 5325 Fastening Devices
 - (f) 5340 Insert, Screw Thread
- 4 There are two primary ways to access fasteners through the Federal Supply Classification. The first is through the use of the Afloat Shopping Guide and the second is the Federal Supply Classification Listing of DoD Standardization Documents, which is a part of the Department of Defense Index of Specifications and Standards (DODISS). The use of these documents is described below.
 - (a) Afloat Shopping Guide (ASG) . The ASG lists the most commonly used items by class. Less frequently used items may be stocked but not listed in the ASG. The description of items in the ASG is often incomplete, and reference to the applicable standard may sometimes be necessary to determine if the part is suitable. The applicable standard usually consists of an MS number and a dash number. If the applicable standard is not identified in the ASG, access the technical characteristics for the NSN. Consolidated data files, such as Parts Master, Haystack, and FEDLOG, may be used to access part numbers and technical characteristics. NSN's are provided for all items in the ASG. Therefore, identification of the standard part number is not required to order the item.
 - (b) Federal Supply Classification Listing (DODISS) . This document is more comprehensive than the ASG but more difficult to use. Classes 5305 and 5306 alone list approximately 1,000 standards for screws and bolts. The listing provides only the title of the standard and the preparing activity. Some standards list material and size in the title, but for others it is often necessary to review the document to determine whether it is applicable. In every case, it will be necessary to review the applicable document to determine if there is a standard part number that can be used to order the required part.

- (c) Level I/Subsafe Stock Program Catalog (NAVSEA 0948-LP-103-6010) . Naval Inventory Control Point - Mechanicsburg publishes this catalog which provides ready identification of Level I/Subsafe fasteners by using activities. The catalog lists materials in the LI/SS Stock Program by noun name and shows the applicable National Stock Number (NSN) or Navy Item Control Number (NICN) to be used in requisitioning material from SPCC (Mechanicsburg, PA) via normal supply channels. (NOTE: There are two volumes of NAVSEA 0948-LP-103-6010; Vol. 1 is for submarines and Vol. 2 is for surface ships.) (See paragraph [075-3.7.3](#) for point of contact.)
- 5 Sometimes the military or Federal specification number can be used as a starting point to identify replacement fasteners.
- (a) Obtain the applicable specification and look in [Section 2](#) under Applicable Documents to see if part standards are referenced. Also look in [Section 6](#) under Military Procurement. [Section 6](#) usually requires that for military use the fasteners be limited to the variety shown on applicable military or industrial standards and then identifies the standards.
- (b) Another alternative is to enter the Master Cross Reference List through the specification number. In the case of MIL-S-1222 fasteners, however, this may require viewing the technical requirements for nearly 3,000 fasteners. Instead, it is recommended that one of the activities identified in paragraph [075-3.7](#) be contacted.

075-2.4 CAPSCREWS AND INTERNAL WRENCHING BOLTS

075-2.4.1 SOCKET-HEAD CAP SCREWS. These fasteners are often used in hydraulic systems such as those found aboard submarines and advanced lightweight surface craft, where the space and weight of the components is limited. The internal hex socket minimizes the size of components, since no space is required outside the bolt-head diameter for a wrench or socket. On socket-head capscrews the head is cylindrical, and the sides of the heads are at right (90-degree) angles to the surface into which the screw is threaded. (See paragraph [075-2.4.2.1](#) for how capscrew heads differ from internal wrenching-bolt heads.) Shipbuilding specifications have required socket-head capscrews to be in accordance with Federal Specification, FF-S-86, Screw, Cap, Socket-Head. For military applications, FF-S-86 requires the capscrews to be manufactured to one of the dimensional standards it lists. The following dimensional standards are listed in FF-S-86; some are identified further in [Table 075-2-2](#).

MS16995	MS24674
MS16996	MS24678
MS16997	MS35455
MS16998	MS35456
MS21262	MS35457
MS21295	MS35458
MS24667	MS35459
MS24671	NAS 1351
MS24673	NAS 1352

075-2.4.1.1 Selecting Dimensional Standard

075-2.4.1.1.1 Replacement Steel Socket Head Cap Screws. Replacement steel socket head cap screws shall be in accordance with National Aerospace Standard (NAS) 1351 and NAS 1352 when available. The replacement cap screws shall be of the same material and finish as those screws previously specified, except as indicated in paragraph [075-2.4.1.3](#). FF-S-86 is the procurement specification for the NAS 1351 and NAS 1352 fasteners as well as the socket head cap screws most commonly used in the past. If the required NAS socket head cap screws are not stocked, the equivalent Military Standard (MS) cap screws may be used.

075-2.4.1.1.2 Replacement Cadmium-Plated Socket Head Cap Screws. Replacement cadmium-plated cap-screws shall be selected from the NAS 1351 and NAS 1352 standards, when available, rather than from the MS standards. The thread forms on the NAS and MS capscrews differ slightly but are interchangeable as long as the number of threads per inch (designated as coarse or fine) is the same. The reasons for using NAS capscrews for replacement are:

- a. Since 1987, NAS 1351 and NAS 1352 capscrews have received a minimum 23-hour bake after plating to provide hydrogen embrittlement relief, whereas most MS cadmium- and zinc-plated capscrews have received only a 3-hour minimum bake.

Table 075-2-2 INTERNAL WRENCHING BOLTS/SOCKET-HEAD CAPSCREWS, SELF-LOCKING OR DRILLED FOR SAFETY WIRING

Procurement Specification	Dimensional Specification	Thread Size	Length*, inches	Material	Tensile Strength	Marking Requirements
MIL-B-7838	MS 20004 through MS 20024	1/4-28 UNJF-3A through 1-1/2-12 UNJF-3A	0.75 to 8.000	Alloy steel	160 ksi	MS number and manufacturer's identification on bolt head
NAS 159 (for new design use MIL-B-7838)	NAS 144 through NAS 158 NAS 172 NAS 174 NAS 176	1/4-28 UNJF-3A through 1/8-12 UNJF-3A 1-1/4-12 UNJF-3A 1-3/8-12 UNJF-3A 1-1/2-12 UNJF-3A	9/16 to 8 1-3/4 to 8 1-7/8 to 8 2 to 8	Alloy steel	160-180 ksi	NAS part number (dash number for length operational) and manufacturer's identification on bolt head
FF-S-86	NAS 1351 NAS 1352	No. 0-80 UNRF-3A through 1-12 UNRF-3A No. 1-64 UNRC-3A through 1-1/2-6 UNRC-2A	1/8 to 5 1/8 to 6	Alloy steel CRES Heat & Corrosion Resistant Steel	170-180 ksi 2bs [1line] (70-80 ksi) 160 ksi	Package to be marked with complete NAS standard part number Package to be marked with complete NAS standard part number
FF-S-86 and MIL-F-18240	MS 21262	No. 4-40 UNC-3A through No. 8-32 UNC-3A No. 10-32 UNF-3A through No. 5/8-18 UNF-3A	3/16 to 1-1/2 5/32 to 3	Alloy steel	160 ksi	Circle of six raised or depressed dots on top of head
FF-S-86	MS 21295	(Same as MS 21262)	(Same as MS 21262)	CRES	80 ksi	Same as MS 21262
FF-S-86	MS 24677	No. 4-40 UNC-3A through 1-8 UNC-3A	1/4 to 6	Alloy steel	170-180 ksi	Package only unless special marking is specified on procurement
FF-S-86	MS 24678	No. 6-40 UNF-3A through 5/8-18 UNF-3A	1/4 to 2-1/2	Alloy steel	170-180 ksi	Package only unless special marking is specified on procurement
FF-S-86	MS 24673	No. 10-32 UNF-3A through 3/8-24 UNF-3A	3/8 to 1-1/2	CRES	70-80 ksi	Package only unless special marking is specified on procurement

Table 075-2-2 INTERNAL WRENCHING BOLTS/SOCKET-HEAD CAPSCREWS, SELF-LOCKING OR
DRILLED FOR SAFETY WIRING - Continued

Procurement Specification	Dimensional Specification	Thread Size	Length*, inches	Material	Tensile Strength	Marking Requirements
FF-S-86	MS 24674	No. 6-32 UNF-3A through 5/8-11 UNC-3A	1/4 to 3	CRES	70-80 ksi	Package only unless special marking is specified on procurement
FF-S-86	As specified	As specified	As specified	Ni-Cu-Al QQ-N-286 Age hardened	130 ksi	Marked •K• or Ni-Cu/K with lot number identification per MS 18116
FF-S-86	MS 16997	No. 2-56 UNF-3A through 1/8 UNC-3A	3/16 to 8	Alloy steel	170 - 180 ksi	Package only unless special marking is specified on procurement
FF-S-86	MS 16998	No. 0-80 UNF-3A through 5/8-18 UNF-3A	1/8 to 3	Alloy steel	160 ksi	Same as MS 16997
*Available lengths vary with each stew diameter. See dimensional specification for complete listing of available thread sizes, diameters, and lengths. # For new designs and replacements use NAS 1352. ## For new designs and replacements use NAS 1351.						

- b. Some of the MS standards have not been updated to reflect current FF-S-86 requirements.
- c. The thickness of the cadmium plating on the NAS capscrews is 0.0003 inch, as opposed to 0.0002 inch on the MS capscrews, and provides improved corrosion resistance.
- d. The NAS capscrew threads have a controlled root radius that provides improved fatigue resistance.
- e. The NAS 1351 and NAS 1352 capscrews are preferred for new design.

075-2.4.1.2 NAS 1351 and NAS 1352 Part Numbers. The NAS 1351 and NAS 1352 part numbering systems are identified in [Table 075-2-3](#). Using this table, you can identify part numbers for replacements for the MS cadmium-plated, socket-head capscrews listed below. For those MS capscrews marked with an (*), substitution for use in counterbored holes for some sizes may be impossible because the NAS capscrews have slightly larger head diameters.

MS16997	MS24677	MS35457*
MS21262*	MS24678*	MS35458*
		MS16998

NAS 1351 covers fine threads; NAS 1352 covers coarse threads. Each NAS standard covers three materials, which are identified in the part number as follows :

- = Alloy steel, 170,000 or 180,000 psi
- C = Corrosion-resistant steel, 80,000 psi
- N = Heat- (and corrosion-) resistant steel, 160,000 psi

Table 075-2-3 NAS 1351 AND NAS 1352 PART NUMBERING SYSTEMS

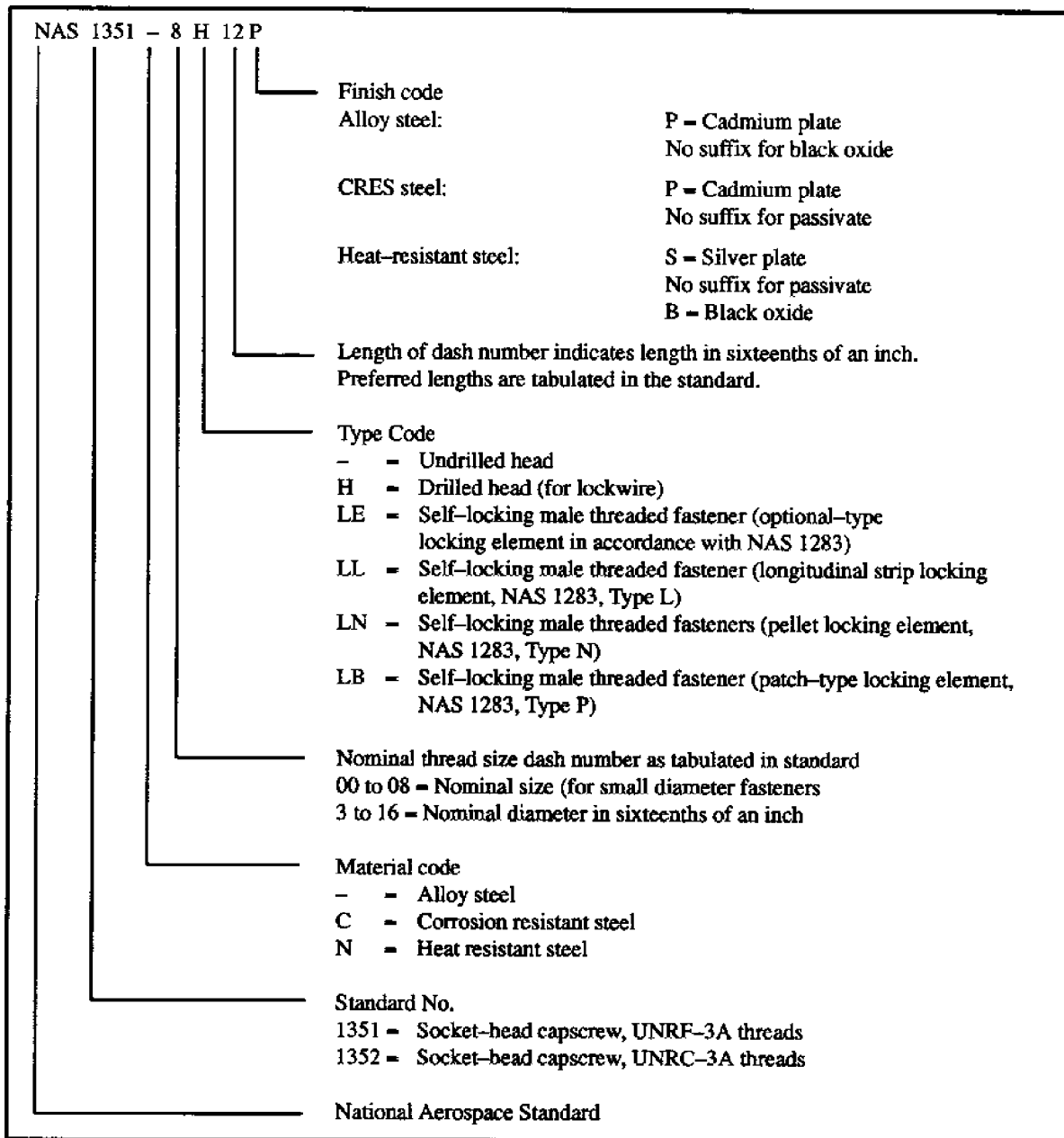

075-2.4.1.3 Authorized Socket-Head Capscrew Substitutions. The following substitutions are authorized for non-nuclear applications.

1. NAS 1351 and NAS 1352.

- a NAS 1351 and NAS 1352 cadmium-plated high-strength alloy steel socket-head capscrews for the equivalent cadmium- and zinc-plated capscrews identified in paragraph 075-2.4.1.2.
- b When rusting of high-strength alloy steel is a problem, substitution of heat and corrosion resistant (A-286

Steel) capscrews per NAS 1351 and NAS 1352 is authorized. (The slightly lower strength is considered to have minimal impact on shock resistance.) The part number for the heat-resistant capscrew is the same as for alloy steel except that the dash (-) in the part number is replaced by an N. This letter N is also found on the head of the fastener for identification purposes. In addition, the last letter of the part number suffix may change to designate a surface finish change. Heat and corrosion resistant capscrews should be silver-plated or have dry film lubricant per MIL-L-46010 applied to minimize the possibility of galling with thread inserts or metals of similar hardness. The silver plate is designated by the suffix letter S, as shown in the example below [Table 075-2-3](#). Dry film lubricant should not be applied to heat and corrosion resistant fasteners where the operating temperature is above 650° F.

- c Replacement of MS corrosion resisting (CRES) cap screws with NAS 1351 and NAS 1352 corrosion resisting (CRES) and Heat and Corrosion Resistant steel cap screws of the same size.
 - d Capscrews identified by size and Electric Boat/General Dynamics (EB/GD) specification 1890 and carrying identification marks S-130 (alloy steel, 160,000 psi minimum tensile strength), and S-150 (alloy steel, 170,000 psi minimum tensile strength) can be replaced by equivalent size NAS 1351 and NAS 1352 capscrews of either cadmium plated alloy steel or heat resisting steel.
2. Example of authorized socket head capscrew substitution: Replace MS24678-57 cadmium plated alloy steel capscrew:
- a Reference to MS24678 or logistic system technical data for MS24678-57 indicates this capscrew is 1.000 inch long with 1/2-20 UNF-3A threads.
 - b Using [Table 075-2-3](#), the equivalent NAS capscrew is: NAS1351 - 8 H 16 P = .500-20 UNRF-3A socket-head capscrew, alloy steel, drilled head, 1.00 inch long, cadmium plated.
 - c The equivalent NAS heat and corrosion resisting fastener is: NAS1351 N 8 H 16 S = .500-20 UNRF-3A socket head cap, heat resisting steel, drilled head, 1.00 inch long, silver plated.

075-2.4.1.4 Socket-Head Capscrew Substitution Requiring NAVSEA Approval. The following substitutions require specific NAVSEA approval:

- a. Substitution of lower strength, corrosion-resistant steel (CRES) socket-head capscrews for higher strength alloy or heat-resistant steel capscrews in applications subject to MIL-S-901, **Hi-shock Requirements** . For applications not subject to MIL-S-901 shock requirements, verify capscrew suitability, using the procedure illustrated in paragraphs [075-4.5.1.2](#) through [075-4.5.1.2.3](#) to find required torque. The lower strength capscrew may be used only if the torque required does not exceed that recommended in [Table 075-4-1](#) for the CRES capscrews. (See [Table 075-4-1](#) column marked 30,000 lb/in² for CRES torque values.)
- b. Substitution of a black-oxide-coated alloy steel socket-head capscrew for one of any other material or coating except for temporary emergency use.

075-2.4.1.5 Identification of Socket Head Cap Screws. Socket head cap screws made of different materials and with different coatings may appear similar but have significant differences in strength and other properties. Therefore, the material and coating should be confirmed by (1) verifying documentation for new screws to be installed and (2) verifying the head marking and magnetic properties in accordance with [Table 075-2-4](#).

CAUTION

When using NAS 144 through 158 and MS20004 through MS20024 bolts, verify that the threaded length of the bolt is satisfactory for the application.

075-2.4.2 INTERNAL WRENCHING BOLTS. These fasteners are similar to the socket head capscrews identified above but have unique characteristics that prevent their direct substitution for socket-head capscrews. The procurement specifications for these bolts are NAS 159 and MIL-B-7838. Only MIL-B-7838 fasteners shall be used for new design; they are preferred for replacement. The dimensional standards for the bolts are NAS144 through 158 and MS20004 through MS20024. These bolts have a relatively large radius between the head and the shank for better fatigue resistance, which precludes use of standard flat washers.

Table 075-2-4 SOCKET HEAD CAP SCREW MATERIAL IDENTIFICATION

Material	Magnetic	Marking
Alloy Steel (cadmium, zinc or black oxide coated) (tensile strength > 150,000 psi)	Yes	None
Austenitic (series 300) CRES, (passivated or cadmium plated) (tensile strength 70,000 psi, yield strength 30,000 psi)	No (May be slightly magnetic)	None
Heat & Corrosion Resisting Steel (passivated or silver or black oxide coating) (tensile strength 160,000 psi)	No	"N" on head
Ni-Cu-Al (K-monel) (uncoated) (tensile strength 130,000 psi, yield strength 90,000 psi)	No	"Ni-Cu" K or "•K•"

CAUTION

Install these bolts using a countersunk washer only. Using a standard washer can induce high stress at the radius between the head and the shank, which will result in bolt failure. Install the bolts with one of the countersunk washers identified in paragraph 075-2.5.1.

075-2.4.2.1 Distinguishing Internal Wrenching Bolts from Socket-Head Capscrews. Because the internal wrenching bolts require countersunk washers, it is important to be able to readily distinguish them from socket-head capscrews. The capscrews have cylindrical heads. The internal wrenching bolt heads are shaped like truncated cones; that is, the side of the head is tapered, with a larger diameter at the bottom of the head than at the top.

075-2.4.2.2 Identification Marking of Internal Wrenching Bolts. The only identification marking on the NAS bolts is an R to indicate rolled threads, although some may be marked with a part number. The MIL-B-7838 bolts are marked with the part number. MIL-B-7838 stock currently contains only bolts with part numbers in accordance with MS20004 through MS20024. (See paragraph 075-2.4.2.3.b.)

075-2.4.2.3 Restrictions on Using Internal Wrenching Bolts. The following restrictions apply to use of internal wrenching bolts:

- a. The bolts must be used only with one of the countersunk washers identified in paragraph 075-2.5.1. The countersink in the washer must face the head of the bolt.
- b. Except for emergency use, internal wrenching bolts must not be substituted for socket head or hex-head capscrews unless approved by NAVSEA. In general, approval will be limited to applications where drawings and

other technical documentation are revised to reflect the change. Another reason for NAVSEA approval is that many of the currently available internal wrenching bolts are not threaded for a sufficient length to use in many hydraulic components, particularly where the bolts are threaded into inserts in aluminum valve bodies.

075-2.4.3 HEXAGON-HEAD CAPSCREWS. Hexagon-head capscrews are covered by Federal Specification FF-S-85 Screw, Cap, Slotted and Hexagon Head. For military applications, the capscrews must be in accordance with the appropriate military standard (see [Table 075-2-5](#)). When identifying replacement capscrews, be sure that the replacement is as strong as the original. If the strength of the original cannot be determined, select a replacement of the same material with the highest strength. Although some of the military standards in [Table 075-2-5](#) have been superseded by ASME B18.2.1 **Part Identifying Numbers**, replacement capscrews can be ordered from the supply system by either the superseded MS numbers or by the ASME B 18.2.1 part identifying numbers. The cancellation notices provide a cross reference between the MS and ASME part numbers.

075-2.4.3.1 ASME B 18.2.1 Part Numbering System. The part numbering system is fully described in the Supplement to ASME B18.2.1, **Bolts and Screws, Inch Series**. B1821BH050C125N is the part number for a 1/2-inch diameter hexagon head, zinc-coated alloy steel capscrew with coarse threads and 1-1/4 inches long. To understand this part number, break it down into its elements and examine each element:

B1821 B H 050 C 125 N

Document identifier:	B1821	=	ANSI B 18.2.1
Material and Finish:	B	=	alloy steel Grade 8 with zinc coating
	A	=	alloy steel Grade 8 with cadmium plating
Fastener Configuration:	H	=	hexagon head
Nominal Diameter:	050	=	diameter in 100ths of an inch (0.50)
Thread Designation:	C	=	UNC thread form (coarse)
	F	=	UNF thread form (fine)
Nominal Length:	125	=	the length in 100ths of an inch (1.25)
Special Features Code:	N	=	None
	D	=	Drilled head for lockwire
	L	=	Self-locking
	C	=	Drilled head and self-locking

WARNING

Wash hands thoroughly after working with cadmium-plated tools or parts to avoid poisoning from ingestion of cadmium.

CAUTION

Do not use zinc or cadmium-plated parts in any hydraulic unit where they may come in contact with hydraulic oil. These coatings react chemically with hydraulic fluid to the detriment of system operation. This restriction does not prohibit the use of zinc or cadmium-plated parts such as nuts, bolts, and screws where they are external to the hydraulic unit if there is no danger of fluid contamination.

075-2.4.3.2 Zinc and Cadmium Plated Hex Head Cap Screws. Zinc and cadmium plated hexagon head cap screws may be ordered by either Military Standard (MS) part numbers or American Society of Mechanical Engineers (ASME) B 18.2.1 part numbers. Applicable standards are:

MS 51491 Steel Grade 5/Zinc plated UNC-2A Threads

MS 90725 Steel Grade 5/Cadmium plated
UNC-2A, Plain Head

MS 90726 Steel Grade 5/Cadmium plated
UNF-2A, Plain Head

ASME B18.2.1 Steel Grade 8/Zinc plated replaces:

MS 18153 Steel Grade 5/Cadmium plated UNF-2A Plain (drilled for lockwire) and Self-locking

MS 18154 Steel Grade 5/Cadmium plated UNC-2A Plain (drilled for lockwire) and Self-locking

MS 90727 Steel Grade 8/Cadmium plated UNF-2A, Plain and Self-locking

MS 90728 Steel Grade 8/Cadmium plated UNC-2A, Plain and Self-locking

The MS numbers replaced by ASME B18.2.1 are still recognized by the supply system but the Defense Industrial Supply Center may supply Grade 8 zinc plated cap screws in lieu of the replaced Grade 5 and Grade 8 cadmium plated screws.

Table 075-2-5 FF-S-85 HEXAGON-HEAD CAPSCREWS

Dimensional Standard	Thread Type	Thread Diameter (in.)	Length ¹ (in.)	Material	Tensile Strength (ksi)	Remarks
MS18153 ²	UNF-2A	1/4 through	0.375 to	Alloy-steel Grade 8	150	Drilled for lockwire
MS18154 ²	UNF-2A	1	6.0			
MS35307	UNC-2A	1/4 through	0.375 to	CRES	70	Undrilled
MS35308	UNF-2A	1-1/4	6.0			
MS35309	UNC-2A	1/4 through	0.375 to	Naval Brass	60,000 to 58,000 (over 1" dia.)	Undrilled
MS35310	UNF-2A	1-1/4	6.0			
MS51095	UNC-2A	1/4 through	0.375 to	Alloy-steel Grade 5	120	Drilled for lockwire
MS51096	UNF-2A	1-1/4	6.0			
MS51105	UNC-2A	1/4 through	0.375 to	Alloy-steel Grade 5	120	Shank drilled for cotter pin
MS51106	UNF-2A	1	6.0			
MS51109	UNC-2A	1/4 through	0.375 to	CRES	70	MS51110
MS51110		1	6.0			
MS51490	UNF-2A	1/4 through	0.75 to	Medium carbon steel Grade 5	120	Finished hex bolt, zinc plated
		3/4	3.0			
MS51491	UNC-2A	1/4 through	0.5 to	Medium carbon steel Grade 5	120 over 1" 105	
		1-1/4	6.0			
MS90725	UNC-2A	1/4 through	0.375 to	Medium carbon steel Grade 5	120 over 1" 105 over 1-1/2" 90	Finished hex bolt, cadmium plated
		2-1/2	6.0			
MS90726	UNF-2A	1/4 through	0.375 to	Medium carbon steel Grade 5	120 over 1" 105	Finished hex bolt, cadmium plated
		1-1/2	6.0			
MS90727 ²	UNF-2A	1/4 through	0.375 to	Alloy-steel Grade 8	150	Plain or self-locking
		1-1/2	6.0			
MS90728 ²	UNC-2A	1/4 through	0.375 to			L-suffix for self-locking
		2-1/2	6.0			

Table 075-2-5 FF-S-85 HEXAGON-HEAD CAPSCREWS - Continued

Dimensional Standard	Thread Type	Thread Diameter (in.)	Length¹ (in.)	Material	Tensile Strength (ksi)	Remarks
<p>¹ Available lengths vary with each screw diameter. See dimensional standard for complete listing of Thread Types, Diameters, and Lengths. ² These standards have been cancelled, but the MS part numbers may be used to order replacement screws (see paragraph 075-2.4.3).</p>						

075-2.4.3.3 Restrictions on the Use of Grade 8, Zinc Plated Hex Head Cap Screws. The Grade 8, 150,000 psi tensile strength, zinc plated hex head cap screws described in paragraphs 075-2.4.3.1 and 075-2.4.3.2 may be susceptible to hydrogen embrittlement failure if the fasteners are highly stressed in service and exposed to severely corroding conditions. For standardization purposes, the Defense Industrial Supply Center has been supplying Grade 8 bolts for several years in support of the following Military Standards for lower strength bolts:

MS18153	MS35763
MS18154	MS35764
	MS90725

The use of the Grade 8, zinc plated fasteners are subject to the following restrictions:

1. The fasteners shall not be used in applications where they would be subject to submergence, wet spaces, or the weather.
2. When replacing a lower strength (Grade 2 or Grade 5) fastener with a Grade 8 fastener, the installation torque for the Grade 8 fastener shall be limited to that for the lower strength fastener being replaced.

075-2.5 WASHERS

075-2.5.1 IDENTIFYING REPLACEMENT WASHERS. The procedures for identifying replacement fasteners, in general, apply to identifying replacement washers. Military Standard MIL-STD-1764 (**Washers, Preferred for Design, Listing of**) lists many different types of washers and includes drawings, part numbers and dimensions which will aid in identifying washers for both new design and replacement. [Table 075-2-6](#) identifies the flat and countersunk washer part numbers that most often apply to hydraulic equipment. Only cadmium-plated steel washers are included in the table.

Table 075-2-6 PART NUMBERS FOR COMMONLY USED ROUND WASHERS

Thread Size (Nominal Diameter)	Alloy Steel - Cadmium Plate		Carbon Steel - Cadmium Plate Flat	
	Countersunk	Plain (flat) ¹	Part No.	Thickness (in.)
No. 6			NAS1149FN432P	0.032
No. 8			NAS1149FN532P	0.032
No. 10			NAS1149F0363P	0.063
1/4	MS20002C4	MS20002-4	NAS1149F0463P	0.063
5/16	MS20002C5	MS20002-5	NAS1149F0563P	0.063
3/8	MS20002C6	MS20002-6	NAS1149F0663P	0.063
7/16	MS20002C7	MS20002-7	NAS1149F0763P	0.063
1/2	MS20002C8	MS20002-8	NAS1149F0863P	0.063
9/16	MS20002C9	MS20002-9	NAS1149F0963P	0.063
5/8	MS20002C10	MS20002-10	NAS1149F1063P	0.063
3/4	MS20002C12	MS20002-12	NAS1149F1290P	0.090
7/8	MS20002C14	MS20002-14	NAS1149F1490P	0.090
1	MS20002C16	MS20002-16	NAS1149F1690P	0.090
1-1/8	MS20002C18	MS20002-18	NAS1149F1890P	0.090
1-1/4	MS20002C20	MS20002-20	NAS1149F2090P	0.090
1-3/8	MS20002C22	MS20002-22		
1-1/2	MS20002C24	MS20002-24		

¹ Thickness is 0.062 inches

075-2.5.2 COUNTERSUNK WASHERS (SINGLE SURFACE). Countersunk washers must be used with the internal wrenching bolts described in paragraph 075-2.4.2. The countersunk face of the washer must be placed under the bolt head to prevent the development of damaging stresses at the head-to-shank fillet radius of the bolt. Table 075-2-6 lists part numbers for both flat (plain) and countersunk washers (one surface) to MS20002 (alloy steel, cadmium plate). CRES countersunk washers (one surface) are available to NAS1587.

075-2.5.3 COUNTERSUNK WASHERS (TWO SURFACES). Washers with both surfaces countersunk are available to part numbers in accordance with MS9482, **Steel-Diffused Nickel Cadmium Plate** ; MS9768, **CRES** ; MS14155, **Alloy Steel, Cadmium Plate** ; and MS14177, **Alloy Steel, Cadmium Plate** . Washers with both surfaces countersunk are usually thicker than washers with only a single surface countersunk. Therefore, do not substitute the two-surface countersunk washers for thinner washers without an engineering analysis to determine that sufficient thread engagement will be maintained. The double countersunk washers may sometimes be substituted when the available replacement fastener is slightly longer than desired, since the increased thickness may prevent the fastener from bottoming in a tapped hole.

075-2.5.4 LOCKWASHERS. Although lockwashers may be encountered, using the flat washers with self-locking nuts, self-locking fasteners, self-locking inserts, or thread sealants such as MIL-S-22473 anaerobic compounds is preferable. Follow the procedures in paragraph 075-2.5.1 to identify replacement lockwashers. (Also, see Table 075-5-2.)

075-2.6 ZINC-PLATED STEEL NUTS AND WASHERS

075-2.6.1 Standards that contain part numbers for zinc-plated steel nuts are identified in Table 075-2-8, and for washers in Table 075-2-9. These zinc-plated steel nuts and washers are to be used only when the applicable drawings specify this material.

075-2.7 THREAD INSERTS

The term thread insert refers to a threaded piece inserted into a tapped hole to form standard size internal threads.

NOTE

Use of thread inserts in MIC LEVEL I/SUBSAFE applications is prohibited unless specifically required by component drawings. Waivers of this prohibition for repair may be sought from NAVSEA on a case-by-case basis.

NOTE

For systems and equipment in nuclear propulsion plants and nuclear support facilities, the use of thread inserts shall be in accordance with Section 9090-3 of the appropriate General Reactor Plant Overhaul and Repair Specification and Section 075 of the **Destroyer Tender and Submarine Tender Nuclear Support Facility Overhaul and Repair Specifications** .

075-2.7.1 PURPOSE OF THREAD INSERT. Thread inserts are used to restore damaged threads in castings or forgings and to protect and strengthen tapped threads in light materials such as plastic and wood and low-shear-strength metals such as aluminum. Thread inserts are typically used in tapped holes for bolting flanges to alumi-

num valve bodies and valve bodies to aluminum subplates. In repair applications, inserts are used to restore damaged tapped holes or existing damaged inserts previously installed in tapped holes. For specific information and guidance on the use and installation of thread inserts, refer to **NSTM Chapter 556, Hydraulic Equipment Power Transmission and Control**.

075-2.8 NONSTANDARD FASTENER APPLICATIONS

075-2.8.1 LEFT-HAND THREAD APPLICATIONS. Some fasteners used on rotating elements of machinery may incorporate left-hand threads to prevent the fastener from loosening during operation. When removing or installing fasteners on rotating elements of machinery, check the applicable technical manual, technical repair standard, manufacturer's instructions, or equipment drawings to determine if left-hand threads have been used. Left-hand threads are turned clockwise to loosen and counterclockwise to tighten. In many applications, fasteners with left-hand threads will have a L, the word left or left hand, an arrow, or some other warning stamped on the head or nut.

Table 075-2-7 NAS 1149 PART NUMBERING SYSTEM FOR ROUND WASHERS

	NAS 1149	C	08	32	B
National Aerospace Standard No. 1149					Finish Code:
Material Code: G - Alloy Steel D - Aluminum Alloy B - Brass, Copper Alloy No. 260 F - Carbon Steel C - Corrosion Resistant Steel (CRES) E - Heat and Corrosion Resistant Steel (CHRES) ASTM A286 T - Titanium (Commercially Pure) V - Titanium 6AL-4V					Alloy Steel P - Cadmium Plate Aluminum Alloy H - None K - Anodize J - Chemical Treat Brass H - None Carbon Steel B - Black Oxide P - Cadmium CRES B - Black Oxide CHRES (A286) P - Cadmium Plate R - Passivate Titanium (Commercially Pure) L - Anodize Titanium 6AL-4V M - Anodize
Diameter Code: N2 through N9 - size numbers 2 through 9 per NAS table 03 through 40 - nominal diameter in sixteenths of an inch (sizes 0.188 and larger) per NAS table					Thickness Code: 16 - 0.016 inch thickness 32 - 0.032 inch thickness 63 - 0.063 inch thickness (sizes No. 10 through 0.625, excluding No. 11) 90 - 0.090 inch thickness (sizes 0.750 through 2.500)
NOTE: NAS 1149 supersedes AN 960					

Table 075-2-8 ZINC-PLATED STEEL NUTS

Table 075-2-8 ZINC-PLATED STEEL NUTS - Continued

Procurement/ Dimensional Specification	Part Identification Number (PIN)	Thread Sizes (in.)	Type and Material
FF-N-845/ MS51468	MS51468-01	.164-32UNC-2B	Plain wing nut of carbon steel with a tensile strength of 50,000 psi
	MS51468-02	.250-20UNC-2B	
	MS51468-03	.3125-18UNC-2B	
	MS51468-04	.373-16UNC-2B	
	MS51468-05	.500-13UNC-2B	
FF-N-836/ MS51469	MS51469-01	.086-56UNC-2B	Plain hexagon nut (machine screw) of carbon steel
	MS51469-02	.138-32UNF-2B	
	MS51469-03	.164-32UNF-2B	
FF-N-836/ MS51470	MS1470-01	.112-48UNF-2B	Plain hexagon nut (machine screw) of carbon steel
	MS1470-02	.138-40UNF-2B	
	MS1470-03	.190-32UNF-2B	
FF-N-836/ MS51471	MS51471-03	.500-13UNC-2B	Plain hexagon nut (jam) of carbon B carbon steel
FF-N-836/ MS51472	MS51472-01	.500-13UNC-2B	Plain hexagon nut of grade B carbon steel
	MS51472-02	1.000-8UNC-2B	
FF-N-836/ MS51473	MS51473-01	.250-28UNF-2B	Plain hexagon nut of grade B carbon steel
	MS51473-02	.3125-24UNF-2B	
	MS51473-03	.4375-20UNF-2	
	MS51473-04	.500-20UNF-2B	
	MS51473-05	.5625-18UNF-2B	
	MS51473-06	.750-16UNF-2B	
	MS51473-07	.875-14UNF-2B	

075-2.8.2 UNIFORM STRENGTH FASTENERS. Uniform strength fasteners are likely to be found in grade A shock designated systems. In particular, uniform strength fasteners are often used for foundation bolting, hull integrity joints in submarines, and bolted piping connections in surface ships located below the full-load water line, which cannot be isolated from the sea by the sea valve. These fasteners are designed so that they can absorb the maximum amount of energy under HI shock loads. Uniform or constant strength fasteners are designed to provide uniform or constant strain over the effective clamping length of the fastener. This is done by proportioning and shaping the various sections of the fastener so that it will stretch (strain) a uniform amount over its entire length, hence the term uniform or constant strength. This is an important requirement, as the ability of these systems to survive HI-shock loads is partially dependent on the ability of the fasteners to absorb energy under these loads. A constant strength fastener minimizes the stress developed while absorbing the shock energy.

075-2.8.2.1 Bolt-Studs. Bolt-studs are the preferred fastener where through bolting can be used. They have the greatest energy absorption capability. Uniform strength in bolt-studs can be achieved by: (1) using continuously threaded bolt-studs (the preferred method with those having roll-formed threads being stronger than those with cut threads), (2) using bolt-studs with roll-formed threads whose unthreaded shank diameter is equal to the pitch diameter, or (3) reducing the unthreaded shank diameter of bolt-studs to the root diameter when cut threads are used. The substitution of bolts or capscrews for studs or bolt-studs in Grade A shock applications is prohibited except by specific approval of NAVSEA.

Table 075-2-9 ZINC-PLATED STEEL WASHERS

Part Identification Number (Pin)	Nominal Washer Size		Inside Diameter (Basic), inch	Outside Diameter (Basic), inch	Thickness (Basic), inch
	No.	Inch			
MS51412-1	No. 6	0.138	0.156	0.375	0.049
MS51412-18	No. 8	0.164	0.188	0.438	0.049
MS51412-2	No. 10	0.190	0.219	0.500	0.049
MS51412-3	3/16	0.188	0.250	0.562	0.049
MS51412-4	1/4	0.250	0.281	0.625	0.065
MS51412-5	1/4	0.250	0.312	0.734	0.065
MS51412-6	5/16	0.313	0.375	0.875	0.083
MS51412-7	3/8	0.375	0.438	1.000	0.065
MS51412-8	7/16	0.438	0.500	1.250	0.083
MS51412-9	1/2	0.500	0.531	1.062	0.095
MS51412-10	1/2	0.500	0.562	1.375	0.109
MS51412-11	3/8	0.625	0.656	1.312	0.095
MS51412-12	3/8	0.625	0.688	1.750	0.134
MS51412-13	3/4	0.750	0.812	1.469	0.134
MS51412-14	3/4	0.750	0.812	2.000	0.148
MS51412-15	1	1.000	1.062	2.500	0.165
MS51412-16	1-1/4	1.250	1.375	3.000	0.165
MS51412-17	1-1/2	1.500	1.625	3.500	0.180

075-2.8.3 HOLES FOR UNIFORM STRENGTH FASTENERS. Tests conducted at David Taylor Research Center (DTRC) have shown that increased fastener shear resistance can be obtained by beveling or rounding off the entrances to the holes for the fastener where the two flanges meet. This reduces the ability of the two flanges to act like a shear and cut the fastener when side loads such as HI shock are applied to the joint. The entrances should have a radius of about 3/32 inch for a typical 1/2-inch or larger fastener. This radius also allows clearance for the increased fillet under the head. Where studs are used, only the mating flange needs to be beveled as the normal hole chamfer takes care of the stud set end side. [Figure 075-2-1](#) illustrates examples of uniform strength fasteners.



a. Continuously threaded bolt-stud.

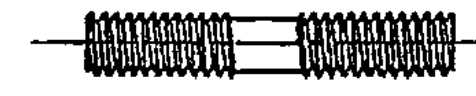

b. Roll formed threads on bolt-stud with unthreaded shank.



c. Cut threads on bolt-stud with reduced diameter unthreaded shank.

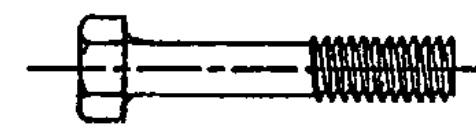

d. Bolt with roll formed threads.

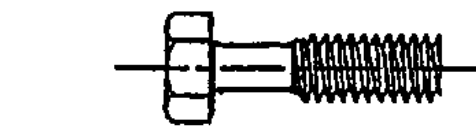

e. Bolt with cut threads.



f. Bolt with cut threads and hole through head and unthreaded shank.

Figure 075-2-1 Uniform Strength Fasteners

SECTION 3. THREADED FASTENER MATERIALS AND MARKING

075-3.1 GENERAL

075-3.1.1 This section provides the information necessary to identify existing fasteners by their markings and determine their physical properties, such as strength and corrosion resistance. It discusses the following subjects:

- a. Level I fastener applications
- b. Fastener requirements and specifications
- c. Fasteners in accordance with MIL-S-1222
- d. Materials
- e. Markings
- f. Corrosion
- g. Coatings
- h. Fastener temperature considerations

075-3.2 MATERIAL REQUIREMENTS AND SPECIFICATIONS

075-3.2.1 FASTENER REQUIREMENTS FOR MIC LEVEL I APPLICATIONS. Level I is a designation for systems and components for which the Navy requires a high degree of assurance that the chemical composition and mechanical properties of the installed materials meet the specified requirements. NAVSEA 0948-045-7010, **Material Control Standard**, establishes a material identification and control (MIC) program for systems and associated components designated as Level I. The Material Control Standard is designed to ensure that the correct material is installed in Level I systems and component installations aboard ship and that such material is traceable to records of objective quality evidence. NAVSEA 0948-045-7010 also provides criteria for determining the Level I systems boundaries.

075-3.2.2 LEVEL I REQUIREMENTS FOR FASTENERS. Appendix C of NAVSEA 0948-LP-7010 contains Level I requirements for fasteners as identified in paragraphs [075-3.2.2.1](#) through [075-3.2.2.3](#).

075-3.2.2.1 Procurement Specifications. Most Level I fasteners are procured to MIL-S-1222. Copper-nickel self-locking nuts should be in accordance with MIL-N-25027/1. FF-S-86 may be used as a procurement specification for socket head cap screws. Fasteners to other specifications can be used when specifically identified by NAVSEA drawings or technical manuals.

075-3.2.2.2 Fastener Identification and Control. Level I and submarine hull integrity fasteners having a nominal diameter 1/2 inch and larger are to be marked with the material grade, manufacturer's trademark or symbol, and a traceability number (i.e., heat number, heat treat number, and/or lot number as applicable). MIL-S-1222 fasteners used in Level I applications are to be procured to lot definition "a" of MIL-S-1222. Socket head cap screws may present an exception to the requirement for material grade marking. A universal material grade marking has not been established for alloy steel socket head cap screws. (See paragraphs [075-2.4.1.3](#) and

075-2.4.1.5 for help in identifying socket head cap screws.) In some cases, manufacturers use a unique knurling pattern for socket head cap screws in lieu of a manufacturer's trademark or symbol.

075-3.2.2.3 Color Coding. For loose fasteners which are not marked with a traceability number, the fasteners are marked with a color code by painting after acceptance at receipt inspection. The materials and the color codes are:

- **Blue** - Carbon and alloy steels of the following grades
 - Nuts - ASTM A194 Grades 2H, 4 and 7
 - Externally threaded - ASTM A 193 Grades B-7, B16 AISI 4340

- **Green** - Nickel-Copper
 - ASTM F 467 and F 468
Grades 400 and 405
Grade 400 marked "NC" or "NICU"
Grade 405 marked "NC-R" or "NICU-R"

 - Nickel-Copper Self-locking Nuts - MIL-N-25027/1
"NICU" - 250° element
"NICUV" - 450° element

- **Pink** - Nickel-Copper-Aluminum - QQ-N-286 marked "•K•"

- **Orange** - Materials other than those above

Color coding does not apply to fasteners supplied as part of an assembly or those with traceability numbers.

075-3.2.3 FASTENER MATERIAL CHARACTERISTICS, IDENTIFICATION MARKINGS AND SUGGESTED USE. [Table 075-3-1](#) lists the material characteristics (chemical and physical) for many of the fastener materials that have been used for Navy ships. Listing in the table does not necessarily reflect current requirements for fastener selection. MIL-STD-438 and MIL-STD-777 identify current requirements for fastener materials for piping system installation. Materials shown on technical documentation should be used unless a substitute is specifically authorized herein.

075-3.2.3.1 Chemical and Physical Properties. Some fasteners are available in more than one grade or strength level for the same alloy. For example, 316 stainless steel is available in four different conditions with the strength level for each condition dependent upon the diameter of the fastener. This means that a fastener identified as being cold worked, strain hardened or heat treated has greater strength characteristics than an annealed fastener or one without these conditions specified. In some cases there are slight differences in strength requirements between industry standards and MIL-S-1222 for the same material condition. In such cases, we have listed the lower value in [Table 075-3-1](#). The differences in requirements are not considered significant enough to affect interchangeability.

075-3.2.3.2 Material Identification Markings. The applicable procurement specification will identify the required marking, if any. Unfortunately, chemically and physically interchangeable fasteners to different specifications have different markings. Commercial fasteners are most often marked in accordance with ASTM fastener standards. ASTM F 1077 (**Standard Guide for Selection of Committee F-16 Fastener Specifications**) provides a relatively rapid and easy to use guide for identifying applicable product markings. However, it is still necessary to refer to the applicable ASTM fastener standard to identify the strength level of the fastener. SAE J429

(**Mechanical and Material Requirements for Externally Threaded Fasteners**) and SAE J995 (**Mechanical and Material Requirements for Steel Nuts**) identify both markings and strength levels for fasteners to these standards. For marking of MIL-S-1222 fasteners, refer to [Table 075-3-1](#). MIL-HDBK-131A, while somewhat outdated, provides identification markings and mechanical properties for many military (AN, MS) fasteners and fasteners to National Aerospace Standards (NAS). The identification markings in [Table 075-3-1](#) list both MIL-S-1222 and commercial markings except that the ASTM F 593 and ASTM F 594 markings for stainless steel fasteners are not included. These are described in the following paragraph.

075-3.2.3.3 **Material Identification Markings for Stainless Steel Fasteners.** Stainless steel fasteners often present the most problems in verifying that the item is of the proper strength. For commercial fasteners, ASTM F 593 (**Screws, Bolts, and Studs**) and ASTM F 594 (**Nuts**) are the procurement standards most often used. These standards divide the alloys into groups with similar properties. Within a group the alloys are considered interchangeable. [Table 075-3-2](#) lists the markings for ASTM F 593 stainless steel bolts, screws and studs. The markings are the same for ASTM F 594 nuts except that "F594" is used instead of "F593." For nuts, alloys 303, XM1, and 303Se are also included in Group 1. Refer either to [Table 075-3-1](#) or ASTM F 593 and ASTM F 594 for strength and hardness requirements. [Table 075-3-3](#) lists identification marking used on 400 series stainless steels.

075-3.2.3.4 **Identifying Material When Fasteners Are Not Marked.** Use of a magnet to identify unmarked fasteners is essential. In fact, it is a good idea to check all fasteners with a magnet as a quick check that the material is proper. In general, highly magnetic fasteners are either alloy or carbon steel and usually have a higher strength than most non or weakly magnetic materials. [Table 075-3-1](#) indicates whether or not specific fasteners are magnetic. [Table 075-2-4](#) provides more information on identification of socket head cap screws. When further identification of fastener materials is required, acid spot checks can be accomplished. NAVSEA 0948-LP-045-7010 Vol. 2, **Material Control Standard**, contains acid spot test procedures for most of the fastener alloys used in ships.

075-3.2.3.5 **Manufacturer's Markings.** Fasteners are often marked with a manufacturer's marking and in the future this may be a requirement for most fasteners. Manufacturer's markings are listed in MIL-HDBK-57.

075-3.3 MIL-S-1222 FASTENERS.

075-3.3.1 **BACKGROUND.** MIL-S-1222 has been used to procure fasteners to a wide range of materials for use in ships. Unfortunately, the lack of part numbers for most fasteners to MIL-S-1222 prevents easy identification of the fasteners and significantly hinders logistic support. Currently, MIL-S-1222 fasteners are recommended primarily for support of applications requiring Level I material identification. MIL-S-1222 also covers a number of coatings. Many materials in MIL-S-1222 should not be coated or plated. In ordering replacement fasteners, the guidance in paragraphs [075-2.3](#) through [075-2.3.3](#) should be followed.

NOTE

Fastener specification MIL-B-857 has been canceled and superseded by MIL-S-1222. See MIL-S-1222 for replacement materials. When specification or part standard revisions are identified on drawings, later revisions may be used. Fasteners to earlier revisions may be installed, including substitution of MIL-B-857 fasteners for MIL-S-1222 fasteners when it is verified that the MIL-B-857 fastener is the same material and condition and possesses adequate strength.

075-3.3.2 MIL-S-1222 FASTENER MATERIAL MARKING. MIL-S-1222 fasteners are permanently marked with the appropriate material grade identified in the specification. For stainless steels, this is likely to be one of the alloys (grades) listed in [Table 075-3-1](#).

075-3.3.2.1 300 Series Stainless. MIL-S-1222 marking requirements have not been as definitive as those of ASTM F 593 and ASTM F 594. Accordingly, a marking of "304", "316" or "321" or other 300 series number on a fastener does not identify the physical condition (annealed, cold worked or strain hardened) and the corresponding strength of the fastener. The symbol "An" after the 300 series alloy (grade) marking, means a lower strength fastener machined from annealed stock or fasteners which have been reannealed after being headed and rolled. The cold worked condition is the industry standard and can be substituted for the lower strength annealed fasteners. Alloys in the same alloy group as identified in [Table 075-3-2](#) are interchangeable. Alloys "303" and "303 Se" do not have satisfactory corrosion resistance and should not be used. Stainless steel fasteners are sometimes ordered to and marked in accordance with ASTM A 193 (**Bolting Materials**) and ASTM A 194 (**Nuts**) for high temperature service. The ASTM A 193 and A 194 marking for stainless most likely to be encountered are:

Alloy	304	316	321	347
Bolts, Screws, Studs	B8 B8A B8N B8NA	B8M B8D	B8T B8J	B8C B8B
Nuts	8 8B 8A 8N 8NB 8NA	8M 8MA 8MB	8T 8TB 8TA	8C 8CB 8CA
Note: If the marking is underlined such as " <u>B8</u> " this indicates strain hardened and higher strength similar to the marking for the ASTM F 593 fasteners.				

075-3.3.2.2 400 Series Stainless Steel. Several different markings have been used for 400 series stainless steel externally threaded fasteners to MIL-S-1222. While MIL-S-1222 materials are in accordance with ASTM F 593, slightly different physical characteristics are required. Marking and yield strength (YS) are compared in [Table 075-3-3](#). Generally this minor difference in strength will not affect interchangeability. However, when technical documentation calls for MIL-S-1222 Alloy 410 H or 416 H, the strength level depends on the revision of MIL-S-1222. In such cases use the higher strength fasteners hardened and tempered at 515°F or consult NAVSEA (see warning).

WARNING

Condition H for Alloys 410 and 416 represents different strength levels in MIL-S-1222 revisions G and H. The actual strength level of fasteners can be determined by their marking. A problem arises if drawings refer to MIL-S-1222 Alloy 410 H (or 416 H) and do not identify either the specification revision or the strength level required. (In such instances, contact NAVSEA for guidance.)

075-3.3.2.3 Marking Locations. The location of markings for each type of fastener is also shown in [Table 075-3-1](#).

075-3.3.3 AVAILABILITY

075-3.3.3.1 Fastener Part Numbers. Unique part numbers are available for some MIL-S-1222 fasteners. The part numbers can be used with appropriate cross references to identify National Stock Numbers. [Table 075-3-4](#) lists the applicable military standards.

075-3.3.3.2 Other Sources. National Stock Numbers also cover other MIL-S-1222 fasteners for which no part numbers exist. A few such fasteners are listed in the Afloat Shopping Guide (NAVSUP Publication 4000 - Stock Number 0588-LP-460-1200), and a more extensive list is given in NAVSEA 0948-LP-103-6010, The Level 1/Subsafe Stock Program Catalog (use the fasteners in this catalog for Level 1/Subsafe applications).

WARNING

Ferrous (carbon steel) fasteners shall not be used in seawater or in other systems where non-ferrous piping is installed. There continues to be a recurring problem with leaks where ferrous fasteners are used in seawater systems. The piping and fittings in these systems are usually made of copper-nickel. Carbon steel fasteners will be subject to galvanic corrosion if coupled with copper-nickel. This has not led to fastener failure but has caused failure of the flange (leakage). This can also be a major maintenance burden as the fastener may have to be cut to facilitate disassembly. There is also a similar problem where ferrous fasteners are installed in nonferrous systems located below the bilge plates.



Material and Type of Fastener	Material Specification, Grade, Type, Class, or Alloy & Condition	Strength in KSI – Yield (Y) Tensile (T) Proof (P)	Hardness, Brinell (B) or Rockwell (R)	Coating Type Permitted (Note: may limit useable temperature)	Temp. Limits for Fastener	Identification Marking	Suggested Usage for Threaded Fasteners
Carbon Steel Stud, Hex Head Bolt & Capscrew	SAE J429 Grade 2 & ASTM A 394 ASTM A 307	Various	Various		Up to 650°F	None	<ol style="list-style-type: none"> 1. Not for pressure sealing applications. 2. Do not use in weather or bilge. 3. Replace with Grade 5 material when replacement is required.
Carbon Steel Nut	SAE J995 Grade 2 & ASTM A 563 Grade O, A, &B				Up to 650°F	None	
Medium Carbon Steel Stud, Hex Head Bolt & Capscrew	SAE J429 Grade 5 & ASTM A 449 Type I	*1/4 – 1 Y = 92 min T = 120 min *1 – 1-1/2 Y = 81 min T = 105 min	*1/4 through 1 (B) 255 to 321 *1 thru 1-1/2 (B) 223 to 285		Up to 650°F		<ol style="list-style-type: none"> 1. Use in piping systems where specified in Mil. Stds. 438 and 777 or piping drawings such as <ol style="list-style-type: none"> a. Steel pressure vessels & piping systems. b. Pipe hangers. c. Foundation & general structural bolting including Grade A HI shock components. 2. Do not use in bilge. 3. Do not use in weather unless nut tapped oversize and thick coating applied to nut & bolt. 4. May be used as replacement for lower grade steel fasteners.
	ASTM A 354 Grade BC	*1/4 – 2-1/2 Y = 109 min T = 125 min	*1/4 – 2-1/2 (B) 255 to 331	Zinc for mild service, 300°F			

Figure 075-3-1 FASTENER MATERIAL CHARACTERISTICS (CHEMICAL AND PHYSICAL), IDENTIFICATION MARKINGS AND SUGGESTED USE



Material and Type of Fastener	Material Specification, Grade, Type, Class, or Alloy & Condition	Strength in KSI – Yield (Y) Tensile (T) Proof (P)	Hardness, Brinell (B) or Rockwell (R)	Coating Type Permitted (Note: may limit useable temperature)	Temp. Limits for Fastener	Identification Marking	Suggested Usage for Threaded Fasteners
	ASTM A 325 Type 1	Y = 81 min T = 105 min	*1/2 through 1 (B) 248 to 331 *1-1/8 thru 1-1/2 (B) 223 to 293				
Medium Carbon Steel Nut	SAE J995 Grade 5 (Per MIL-S-1222) & ASTM A 563 Grade C SAE J995 Grade 5	SAE J995 *1/4 thru 1 P = 120 over *1P = 105 ASTM A 563 Grade C P = 144	*1/4 to 4 (B) 143 to 352		Up to 650°F	 	

Figure 075-3-1 FASTENER MATERIAL CHARACTERISTICS (CHEMICAL AND PHYSICAL), IDENTIFICATION MARKINGS AND SUGGESTED USE (cont.)



Material and Type of Fastener	Material Specification, Grade, Type, Class, or Alloy & Condition	Strength in KSI – Yield (Y) Tensile (T) Proof (P)	Hardness, Brinell (B) or Rockwell (R)	Coating Type Permitted (Note: may limit useable temperature)	Temp. Limits for Fastener	Identification Marking	Suggested Usage for Threaded Fasteners
Medium Carbon Alloy Steel Stud, Hex Head Bolt & Capcrew	SAE J429 Grade 8 & ASTM A 354 Grade BD	Y = 130 min T = 150 min	*1/4 thru 1-1/2 (B) 311 to 363		Up to 650°F		<ol style="list-style-type: none"> 1. High-strength general purpose fastener for joining steel components. 2. Use in piping systems where specified in Mil. Subs. 438 and 777 or piping drawings. 3. Use heavy hex bolt series. 4. Requires heavy hex nut to develop full strength. 5. See 075-2.4.3.3 for restrictions on the use of Grade 8 plated fasteners including substitutions for lower grade fasteners. 6. Plated Grade 8 fasteners are not for use in the weather, bilge, or high humidity areas. Unplated Grade 8 fasteners may be used in these applications when coated as described in 075-3.4.2.1.
	ASTM A 490 Type 1	Y = 130 min T = 150 min	*1/2 thru 1-1/2 (B) 311 to 352				
Alloy Steel Nut	SAE J995 Grade 8 (per MIL-S-1222)	SAE J995 Grade 8 P = 150	(B) 248 to 352	Black Oxide Only; due to Hydrogen embrittlement concerns associated with nuts and/or bolts and their combinations.	Up to 650°F		

Figure 075-3-1 FASTENER MATERIAL CHARACTERISTICS (CHEMICAL AND PHYSICAL), IDENTIFICATION MARKINGS AND SUGGESTED USE (cont.)

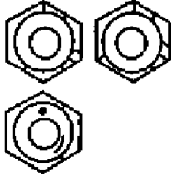

Material and Type of Fastener	Mineral Specification, Grade, Type, Class, or Alloy & Condition	Strength in ENI - Yield (Y) Tensile (T) Proof (P)	Hardness, Brinell (B) or Rockwell (R)	Coating Type Permitted (Note: may limit useable temperature)	Temp. Limits for Fastener	Identification Marking	Suggested Usage for Threaded Fasteners
	EAE 1995 Grade B			Use only in dry locations above the piping ridge area.			
Alloy Steel Cr-Ni Stud, Hex Head Bolt & Cap screw	ASTM A 320 Grade 17	Y = 103 min T = 124 min	None Specified		-60°F to 715°F	 Alloy "L70"	<ol style="list-style-type: none"> 1. Low temperature service, 60°F to 875°F for joining steel components. 2. Use special ASTM A 194 Grade 7 nut washers for low-temperature applications. Testing requirements shall be in accordance with ASTM A 320. 3. Use heavy hex screws series 8 except that max. body diameter and F1 flat radius may be the same as Heavy Hex Bolt Series. 4. May not be stock'd. Consult NAPS® A for replacement.

Figure 075-3-1 FASTENER MATERIAL CHARACTERISTICS (CHEMICAL AND PHYSICAL), IDENTIFICATION MARKINGS AND SUGGESTED USE (cont.)

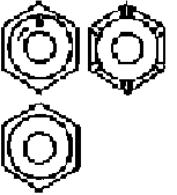

Material and Typical Fastener	Material Specification, Grade, Type, Class, or Alloy & Condition	Strength in KSI - Yield (Y) Tensile (T) Proof (P)	Elongation, Brinell (B) or Rockwell (R)	Welding Type Permitted (Notes may limit use at temperature)	Temp. Limits for Fastener	Identification Marking	Suggested Usage for Threaded Fasteners
Alloy Steel Ni-Cr-Mo Stud, Hex Hex Bolt & Washer	ASTM A 322 Grade L43	Y = 134 min T = 175 min	None Specified		-60°F to 775°F		<ol style="list-style-type: none"> Low-temperature service, -60°F to 775°F, for joining steel components. Better low-temperature impact resistance than Grade L5. Use heavy hex screws unless exact diam body diameter and 7/16" dia may be used as Heavy Hex Bolt Style. The ASTM A 194 Grade 7 nut not intended for low-temp use. Testing requirements shall be in accordance with ASTM A 194. May not be used. Consult NAVSEA for replacement.
Alloy Steel C-Mn Nut	ASTM A 193 Grade 4	Y = 175 For heavy hex	(R) 248 to 352		-60°F to 875°F	 4B, nut from bar	<ol style="list-style-type: none"> Nuts for ASTM A 193 B7 and B16 high temperature bolts. Grade 4 nuts should not be used in applications where prolonged exposure to temperatures above 875°F may occur. Unthreaded Grade 4 collar may be replaced with Grade 7 nuts.
Alloy Steel Cr-Mn Nut	ASTM A 194 Grade 7	Y = 175 For heavy hex	(R) 248 to 352		-60°F to 775°F	 7B, nut from bar	<ol style="list-style-type: none"> For gaskets, beam hangers, and piping in 875°F or specified on drawing and MIL Specs 438 & 727. Use with ASTM A 193-Grade B7 and B16 bolts.

Figure 075-3-1 FASTENER MATERIAL CHARACTERISTICS (CHEMICAL AND PHYSICAL), IDENTIFICATION MARKINGS AND SUGGESTED USE (cont.)



Material and Type of Fastener	Material Specification, Grade, Type, Class, or Alloy & Condition	Strength in KSI - Yield (Y) Tensile (T) Proof (P)	Hardness, Brinell (B) or Rockwell (R)	Coating Type Permitted (Note: may limit useable temperature)	Temp. Limits for Fastener	Identification Marking	Suggested Usage for Threaded Fasteners
Alloy Steel Cr-Mo Stud, Hex Head Bolt & Capscrew	ASTM A 193 Grade B7	up to *2-1/2 Y = 100 min T = 125 min	None specified	None Use only in dry locations above the piping bilge area.	Up to 775°F		<ol style="list-style-type: none"> For pressure boundaries and piping to 775°F as specified on drawings and Mil. Stds. 438 & 777. Use heavy hex screws series. B7 may be replaced with B16.
Alloy Steel Cr-Mo V Stud, Hex Head Bolt & Capscrew	ASTM A 193 Grade B16	up to *2-1/2 Y = 100 min T = 125 min	None specified		Up to 1000°F		<ol style="list-style-type: none"> For pressure boundaries and piping to 1000°F as specified on drawings and Mil. Stds. 438 & 777. Use heavy hex screws series. Heavy hex nut required. (Grade 7)
Carbon Steel Nut	ASTM A 194 Grade 2H	P = 175	up to *1-1/2 (B) 248 to 352 over *1-1/2 (B) 212 to 352		Up to 650°F	 2HB, mfg from bar	<ol style="list-style-type: none"> Nuts for Grade B7 bolts. Heavy hex nut required. When replacing damaged Grade 2H nuts, replace with Grade 7 nuts.
Alloy Steel Socket head cap screw	ASTM A 574 Grade 574	T = 170 min		Use only in dry locations above the piping bilge area.		None (Magnetic)	<ol style="list-style-type: none"> For replacement see paragraph 075-2.4.1.1.1.

Figure 075-3-1 FASTENER MATERIAL CHARACTERISTICS (CHEMICAL AND PHYSICAL), IDENTIFICATION MARKINGS AND SUGGESTED USE (cont.)



Material and Type of Fastener	Material Specification, Grade, Type, Class, or Alloy & Condition	Strength in KSI - Yield (Y) Tensile (T) Proof (P)	Hardness, Brinell (B) or Rockwell (R)	Coating Type Permitted (Note: may limit useable temperature)	Temp. Limits for Fastener	Identification Marking	Suggested Usage for Threaded Fasteners
CRES, Austenitic, Non-magnetic in Annealed (A or AF) Cond. Stud, Hex Head Bolt & Capscrew	ASTM F 593 group 2 316 cond CW, A, or AF	CW, *1/4 to 5/8 Y = 65 T = 100 to 150 CW, *3/4 to 1-1/2 T = 85 to 140 Y = 45 A, T = 75 - 100 Y = 30 AF, T = 85 max	(R) CW, *1/4 to 5/8 95B to 32C CW, *3/4 to 1-1/2 80B to 32C A, 65 to 95B AF, 85B max	None	600°F when exposed to seawater 120°F		<ol style="list-style-type: none"> 1. Can be cold-worked to a variety of strengths but then becomes magnetic. Low strength above 600°F. 2. Do not use in 600 psi & above steam systems. 3. More corrosion resistant than ASTM F 593 group 1 bolts. 4. Not interchangeable with bolts or nuts from other groups. Use only ASTM F 594 group 2 nuts. 5. Same applications as ASTM F 593 group 1 where increased corrosion resistance is desired.
CRES, as above Nut	ASTM F 594 group 2 316 cond CW, A, or AF	CW, *1/4 to 5/8 P = 100 CW, *3/4 to 1-1/2 P = 85 A, P = 75 AF, P = 70	(R) CW, *1/4 to 5/8 95B to 32C CW, *3/4 to 1-1/2 80B to 32C A, 65 to 95B AF, 85B max	None	600°F		<ol style="list-style-type: none"> 1. Nuts for ASTM F 593 group 2 bolts. 2. Do not use with steel washers, pins, wires, or other small carbon or alloy steel items due to potential galvanic corrosion of those items. 3. May not be stocked. Consult NAVSEA for replacement.

Figure 075-3-1 FASTENER MATERIAL CHARACTERISTICS (CHEMICAL AND PHYSICAL), IDENTIFICATION MARKINGS AND SUGGESTED USE (cont.)



Material and Type of Fastener	Material Specification, Grade, Type, Class, or Alloy & Condition	Strength in KSI - Yield (Y) Tensile (T) Proof (P)	Hardness, Brinell (B) or Rockwell (R)	Coating Type Permitted (Note: may limit useable temperature)	Temp. Limits for Fastener	Identification Marking	Suggested Usage for Threaded Fasteners
CRES, Austenitic Non-magnetic in Annealed (A or AF) Cond. Stud, Hex Head Bolt & Capscrew	ASTM F 593 group 3 321, 347 cond CW, A, or AF	CW, *1/4 to 5/8 Y = 65 T = 100 to 150 CW, *3/4 to 1-1/2 Y = 45 T = 85 to 140 A, T = 75 to 100 AF, T=85 max	(R) CW, *1/4 to 5/8 95B to 32C CW, *3/4 to 1-1/2 80B to 32C A, 65 to 95B AF, 85B max	None	1125°F for low strength use only	 321 or 347 as applicable (See 075-3.3.2.1)	<ol style="list-style-type: none"> 1. Can be cold-worked to a variety of strengths but then become magnetic. Low strength above 600°F. 2. Do not use in 600 psi & above steam systems. 3. Not interchangeable with bolts or nuts from other groups. Use only ASTM F 594 group 3 nuts. 4. Used for high-temperature applications up to 1125°F where low stresses are involved such as diesel exhaust, & gas turbine exhaust & bleed air. 5. May be used for fastening steel or aluminum materials exposed to the weather. 6. May not be stocked. Consult NAVSEA for replacement.
CRES, as above Nut	ASTM F 594 group 3 321, 347 cond CW, A, or AF	CW, 1/4 to 5/8 P=100 CW, 3/4 to 1-1/2 P=85 A, P=75 AF, P=70		None	1125°F for low strength use only	 321 or 347 as applicable (See 075-3.3.2.1)	<ol style="list-style-type: none"> 1. Nuts for ASTM F 593 group 3 bolts. 2. Do not use with steel washers, pins, wires, or other small carbon or alloy steel items due to potential galvanic corrosion of those items. 3. May not be stocked. Consult NAVSEA for replacement.

Figure 075-3-1 FASTENER MATERIAL CHARACTERISTICS (CHEMICAL AND PHYSICAL), IDENTIFICATION MARKINGS AND SUGGESTED USE (cont.)



Material and Type of Fastener	Material Specification, Grade, Type, Class, or Alloy & Condition	Strength in KSI - Yield (Y) Tensile (T) Proof (P)	Hardness, Brinell (B) or Rockwell (R)	Coating Type Permitted (Notes may limit useable temperature)	Temp. Limits for Fastener	Identification Marking	Suggested Usage for Threaded Fasteners
CRES, Martensitic Magnetic Stud, Hex Head Bolt & Capscrew	ASTM F 593 group 5 alloys 410, 416, and 416Se See Table 075-3-3 and 075-3.3.2.2 for heat treat conditions and strength		(R) H, 20 to 30C HT, 34 to 45C For MIL S-1222 Cond HT 38-47C	None	400°F	 410, 416 or 416Se as applicable. See Table 075-3-3 for additional markings	<ol style="list-style-type: none"> 1. Not interchangeable with bolts or nuts from other groups. Use only CRES group 5 nuts of same condition. 2. Used where increased corrosion resistance is required. 3. Not for use in weather, bilge or submerged locations. 4. May not be stocked. Consult NAVSEA for replacement.
CRES, as above Nut	ASTM F 594 group 5 410, 416, 416Se cond H or HT	H, P=110 min HT, P=160 min		None	600°F		<ol style="list-style-type: none"> 1. Nuts for group 5 bolts. May be used with any group 5 bolt provided they are the same condition. 2. Do not use with steel washers, pins, wires, or other small steel items due to potential galvanic corrosion of those items. 3. May not be stocked. Consult NAVSEA for replacement.
CRES, Martensitic Magnetic Stud, Hex Head Bolt & Capscrew	ASTM F 593 group 6 431 cond H or HT	H, Y=100 T=125 to 150 HT, Y=140 T=180 to 220	(R) H, 25 to 32C HT, 40 to 48C	None	600°F		<ol style="list-style-type: none"> 1. Magnetic, hardened and tempered to two strength levels, H, equivalent to ASTM A 449 type 1, or HT equivalent to ASTM A 354 Grade BD. 2. Not interchangeable with bolts or nuts from other groups. Use only CRES group 6 nuts of same condition. 3. Not recommended for high temperature use above 600°F. 4. Used instead of Type 1 or Grade BD where increased corrosion resistance is required. 5. Not for use in weather, bilge or submerged locations.

Figure 075-3-1 FASTENER MATERIAL CHARACTERISTICS (CHEMICAL AND PHYSICAL), IDENTIFICATION MARKINGS AND SUGGESTED USE (cont.)



Material and Type of Fastener	Material Specification, Grade, Type, Class, or Alloy & Condition	Strength in KSI - Yield (Y) Tensile (T) Proof (P)	Hardness, Brinell (B) or Rockwell (R)	Coating Type Permitted (Note: may limit useable temperature)	Temp. Limits for Fastener	Identification Marking	Suggested Usage for Threaded Fasteners
CRES, as above Nut	ASTM F 594 group 5 431 cond H or HT	H, P=125 min HT, P=180 min			800°F		<ol style="list-style-type: none"> Nuts for group 6 bolts. May be used with any group 6 bolt provided they are the same condition. Do not use with carbon or alloy steel washers, pins, wires, or other small steel items due to potential galvanic corrosion of those items.
CRES, Precipitation Hardening Alloy, Magnetic Stud, Hex Head Bolt & Capscrew	ASTM F 593 group 7 630 cond AH	Y=105 T=135 to 170	(R) 28 to 38C	None	800°F		<ol style="list-style-type: none"> Solution annealed and age hardened after forming, magnetic. Not interchangeable with bolts or nuts from other groups.
CRES, as above Nut	ASTM F 594 group 7 630 cond AH	P=135 min	(R) 28 to 38C	None	800°F		<ol style="list-style-type: none"> Nut for use with 630 bolts. Do not use with carbon or alloy steel washers, pins, wires, or other small steel items due to potential galvanic corrosion of those items.

Figure 075-3-1 FASTENER MATERIAL CHARACTERISTICS (CHEMICAL AND PHYSICAL), IDENTIFICATION MARKINGS AND SUGGESTED USE (cont.)



Material and Type of Fastener	Material Specification, Grade, Type, Class, or Alloy & Condition	Strength in KSI – Yield (Y) Tensile (T) Proof (P)	Hardness, Brinell (B) or Rockwell (R)	Coating Type Permitted (Note: may limit useable temperature)	Temp. Limits for Fastener	Identification Marking	Suggested Usage for Threaded Fasteners
CRES, Age Hardenable Austenitic Alloy, nonmagnetic Stud, Hex Head Bolt & Capscrew	ASTM A 453 Grade 660 Class A cond AH	Y=85 min T=130 min	(R) 99B to 37C	None	1200°F		<ol style="list-style-type: none"> 1. Age hardenable bolts, non-magnetic. 2. May not be replaced with lower strength CRES bolts or nuts. May be used as replacement for lower strength CRES bolts or nuts. 3. High strength, for high temperature, 1200°F, applications such as pressure vessels & valve flanges. 4. May be used to fasten steel or aluminum materials exposed to the weather. 5. For applications above 800° F, a stress rupture test is required. Fasteners stamped "NR" have not been subject to a stress rupture test and are not to be used for applications above 800° F.
CRES, as above Nut	ASTM A 453 Grade 660 Class A cond AH	Y=55 min T=130 min	(R) 99B to 37C	None	1200°F		<ol style="list-style-type: none"> 1. Nut for use with 660 bolts. 2. For applications above 800° F, a stress rupture test is required. Fasteners stamped "NR" have not been subject to a stress rupture test and are not to be used for applications above 800° F. 3. Do not use with carbon or alloy steel washers, pins, wires, or other small steel items due to potential galvanic corrosion of those items.

Figure 075-3-1 FASTENER MATERIAL CHARACTERISTICS (CHEMICAL AND PHYSICAL), IDENTIFICATION MARKINGS AND SUGGESTED USE (cont.)



Material and Type of Fastener	Material Specification, Grade, Type, Class, or Alloy & Condition	Strength in KSI – Yield (Y) Tensile (T) Proof (P)	Hardness, Brinell (B) or Rockwell (R)	Coating Type Permitted (Note: may limit useable temperature)	Temp. Limits for Fastener	Identification Marking	Suggested Usage for Threaded Fasteners
Ni-Cu Monel & R-Monel Stud, Hex Head Bolt & Capscrew & socket head capscrew	ASTM F 468 Alloy 400, Monel Ni-Cu Class A Alloy 405, R-Monel Ni-Cu Class B QQ-N-281	Alloy 400, *1/4 to 3/4 Y=40 T=80 to 130 *7/8 to 1-1/2 Y=30 T=70 to 120 Alloy 405, Y=30 T=70 to 125	(R) Alloy 400, *1/4 to 3/4 75B to 25C *7/8 to 1-1/2 60B to 25C Alloy 405, 60B to 20C	None	600°F	 NC, Ni-Cu, or NC-R as applicable. May have A or B for class.	<ol style="list-style-type: none"> Piping systems as specified in drawings and Mil. Stds. 438 and 777. General purpose, moderate strength, good corrosion resistance. For use with most nonferrous & steel components in wet or submerged applications. Not for use in Hull Integrity applications.
Ni-Cu, Monel & R-Monel Nut	ASTM F 467 Alloy 400, Ni-Cu Class A Alloy 405, Ni-Cu Class B QQ-N-281	Alloy 400, P=80 min Alloy 405, P=70 min	(R) Alloy 400, 75B min Alloy 405, 60B min	None	600°F	 NC, Ni-Cu, or NC-R as applicable	<ol style="list-style-type: none"> Nickel-Copper alloy 400 (Monel) and 405 (R-Monel) nuts for use with alloy 400 and 405 bolts. Also, used with alloy 500 bolts and studs.
Ni-Cu-Al, K-Monel Stud, Hex Head Bolt & Capscrew & socket head capscrew	ASTM F 468 Alloy 500 QQ-N-286	*1/4 to 7/8 Y=90 min T=130 to 180 *1 to 1-1/2 Y=85 min T=130 to 180	(R) 24 to 37C	None	600°F	 May have 'K'.	<ol style="list-style-type: none"> Piping systems as specified in drawings and Mil. Stds. 438 and 777. High strength, good corrosion resistance. Use with most nonferrous & steel components in wet or submerged applications requiring corrosion resistant high strength foundation and/or bedplate hold down fasteners for HI shock. Surface ship & submarine hull integrity bolting.

Figure 075-3-1 FASTENER MATERIAL CHARACTERISTICS (CHEMICAL AND PHYSICAL), IDENTIFICATION MARKINGS AND SUGGESTED USE (cont.)





Material and Type of Fastener	Material Specification, Grade, Type, Class, or Alloy & Condition	Strength in KSI - Yield (Y) Tensile (T) Proof (P)	Hardness, Brinell (B) or Rockwell (R)	Coating Type Permitted (Note: may limit useable temperature)	Temp. Limits for Fastener	Identification Marking	Suggested Usage for Threaded Fasteners
Ni-Cu-Al, K-Monel Nut	ASTM F 467 Alloy 500 QQ-N-286	F=130 min	(R) 24C min	None	600°F		1. Because of potential galling problems when used with male fasteners of a like material, nuts of this material are not stocked or recommended for use. 2. Usually, heavy hex nuts of ASTM alloy 400 or 405 may be substituted. In Level I, heavily loaded or other critical applications, obtain engineering approval for the substitution.
Naval Brass Stud, Hex Head Bolt & Capscrew Non-magnetic	ASTM F 468 Alloy 462	Y = 25 min T = 50-80	(R) 65-90B	None	250°F	 May have F468C	1. Seawater applications 250 PSI and below. 2. Piping systems as specified in drawings and MIL Stds. 438 and 777. 3. Limited low-temperature (250°F) and low stress use, such as valve stem packing gland & handwheel nuts.
Naval Brass Stud, Hex Head Bolt & Capscrew Non-magnetic	ASTM F 468 Alloy 464	Y = 15 min T = 50-80	(R) 55-75B	None	250°F	 May have F468D	1. Seawater applications 250 PSI and below. 2. Piping systems as specified in drawings and MIL Stds. 438 and 777. 3. Limited low-temperature (250°F) and low stress use, such as valve stem packing gland & handwheel nuts.
	QQ-B 637 482				250°F		

Figure 075-3-1 FASTENER MATERIAL CHARACTERISTICS (CHEMICAL AND PHYSICAL), IDENTIFICATION MARKINGS AND SUGGESTED USE (cont.)





Material and Type of Fastener	Material Specification, Grade, Type, Class, or Alloy & Condition	Strength in KSI - Yield (Y) Tensile (T) Proof (P)	Hardness, Brinell (B) or Rockwell (R)	Coating Type Permitted (Note: may limit useable temperature)	Temp. Limits for Fastener	Identification Marking	Suggested Usage for Threaded Fasteners
Naval Brass Nut Non-magnetic	ASTM F 467 Alloy 462	P = 50 min	(R) 65B min	None	250°F	 May have F467C	1. Naval brass nuts for use with alloy 462 & 464. 2. WARNING: Most of the brass fasteners in the supply system are black oxide coated. See 075-3.4.3.3.2 for instructions concerning the replacement of these fasteners.
	ASTM F 467 Alloy 464	P = 50 min	(R) 55B min		250°F	 May have F467D	
Phosphor bronze Stud, Hex Head Bolt & Capscrew Non-magnetic	ASTM F 468 Alloy 510	Y = 35 min T = 60-90	(R) 60-95B	None	400°F	 May have F468E	1. Moderate strength for general purpose use such as nonferrous flanged pipe joint bolting where pressures are below 250 psi and temperatures below 400°F.
	ASTM B 139 Alloy 544						

Figure 075-3-1 FASTENER MATERIAL CHARACTERISTICS (CHEMICAL AND PHYSICAL), IDENTIFICATION MARKINGS AND SUGGESTED USE (cont.)





Material and Type of Fastener	Material Specification, Grade, Type, Class, or Alloy & Condition	Strength in KSI - Yield (Y) Tensile (T) Proof (P)	Hardness, Brinell (B) or Rockwell (R)	Coating Type Permitted (Note: may limit useable temperature)	Temp. Limits for Fastener	Identification Marking	Suggested Usage for Threaded Fasteners
As above Nut	ASTM F 467 Alloy 510	P = 50 min	(R) 60B min	None	400°F	 May have F467E	1. Phosphor bronze nuts for use with alloy 510 & 544 bolts.
Nickel-aluminum bronze Stud, Hex Head Bolt & Capscrew Non-magnetic	QQ-C-465 632 ASTM F 468 Alloy 630	Y = 50 min T = 100-130	(R) 85-100B	None	400°F	 May have F468H	1. High strength, for general purpose use such as nonferrous flanged joint bolting for seawater, fire main, and low pressure steam up to 400°F.
As above Nut	QQ-C-465 632 ASTM F 467 Alloy 630	P = 100 min	(R) 85B min	None	400°F	 May have F467H	1. Nickel Aluminum Bronze nuts for use with alloy 630 bolts.
Silicon Bronze Stud, Hex Head Bolt & Capscrew Non-magnetic	ASTM F 468 Alloy 651, 655, 661	651 <.875 Y=55, T=70 651 >.750 Y=40 T=55 655 Y=20, T=50 661 Y=35, T=70	75-95 HRB 70-95 HRB 60-80 HRB 75-95 HRB	None	400°F	 651 or F 468K 655 or F 468L 661 or F 468M	1. Moderate strength material for general purpose use such as in nonferrous flanged bolting for pressures below 250 psi and not in contact with sea water. 2. Use same alloy nut and bolt. 3. Use only when permitted by technical documentation.

Figure 075-3-1 FASTENER MATERIAL CHARACTERISTICS (CHEMICAL AND PHYSICAL), IDENTIFICATION MARKINGS AND SUGGESTED USE (cont.)



Material and Type of Fastener	Material Specification, Grade, Type, Class, or Alloy & Condition	Strength in KSI - Yield (Y) Tensile (T) Proof (P)	Hardness, Brinell (B) or Rockwell (R)	Coating Type Permitted (Note: may limit useable temperature)	Temp. Limits for Fastener	Identification Marking	Suggested Usage for Threaded Fasteners
As above Nut	ASTM F 467 Alloy 651, 655, 661	651, 661 P = 70 min 655 P = 30	(R) 651, 75B min 655, 60B min	None	400°F	 651 or F 467K 655 or F 467L 661 or F 467M	<ol style="list-style-type: none"> 1. Silicon bronze nuts for use with alloy 651, 661, & 655 bolts. 2. Use same alloy nut and bolt. 3. Use only when permitted by technical documentation.
Manganese Bronze Stud, Hex Head Bolt & Capscrew Non-magnetic	ASTM F 468 (B 138) Alloy 675 (670)	Y = 25 min T = 55-85	(R) 60-90B	None		 670 old designation May have F468N	<ol style="list-style-type: none"> 1. Manganese bronze, low strength non-magnetic copper alloy. 2. Limited low temperature, low stress general purpose use such as valve stem packing glands & handwheel nuts.
As above Nut	ASTM F 467 (B 138) Alloy 675 (670)	P = 55 min	(R) 60B min	None		 670 old designation May have F467N	<ol style="list-style-type: none"> 1. Manganese bronze nut for use with alloy 675 bolts.

Figure 075-3-1 FASTENER MATERIAL CHARACTERISTICS (CHEMICAL AND PHYSICAL), IDENTIFICATION MARKINGS AND SUGGESTED USE (cont.)





Material and Type of Fastener	Material Specification, Grade, Type, Class, or Alloy & Condition	Strength in KSI – Yield (Y) Tensile (T) Proof (P)	Hardness, Brinell (B) or Rockwell (R)	Coating Type Permitted (Note: may limit useable temperature)	Temp. Limits for Fastener	Identification Marking	Suggested Usage for Threaded Fasteners
Aluminum alloy Stud, Hex Head Bolt & Capscrew Non-magnetic	ASTM F 468 Alloy 2024 Temper T-4	Y = 36 min T = 55-70	(R) 70-85B	Subject to severe corrosion when in contact with steel in wet or humid areas, see 075-3.4.1.		 May have F468X	1. Limited shipboard application. Use only where specified. 2. Bolting for use with aluminum piping and structures in the superstructure, and interior bulkheads & inner-work.
	ASTM F 468 Alloy 6061 Temper T-6	Y = 31 min T = 37-52	(R) 40-50B			 May have F468Y	
	ASTM F 468 Alloy 7075 Temper T-73	Y = 50 min T = 61-76	(R) 80-90B			 May have F468Z	
As above Nut	ASTM F 467 Alloy 2024 Temper T-4	P = 55 min	(R) 70B min	As above		 May have F467X	1. Aluminum nuts for use with alloy 2024-T4 bolts. 2. Not recommended for sizes above .250".

Figure 075-3-1 FASTENER MATERIAL CHARACTERISTICS (CHEMICAL AND PHYSICAL), IDENTIFICATION MARKINGS AND SUGGESTED USE (cont.)





Material and Type of Fastener	Material Specification, Grade, Type, Class, or Alloy & Condition	Strength in KSI - Yield (Y) Tensile (T) Proof (P)	Hardness, Brinell (B) or Rockwell (R)	Coating Type Permitted (Note: may limit useable temperature)	Temp. Limits for Fastener	Identification Marking	Suggested Usage for Threaded Fasteners
As above Nut	ASTM F 467 Alloy 6061 Temper T-6	P = 40 min	(R) 40B min	As above		 May have F467Y	1. Aluminum nuts for use with alloy 6061-T6 bolts.
As above Nut	ASTM F 467 Alloy 6262 Temper T-9	P = 52 min	(R) 60B min	As above		 May have F467Z	1. Aluminum nuts for use with alloy 7075-T73 bolts.
Titanium alloy Std. Hex Head Bolt & Capscrew Non-magnetic:	MIL-T-9047 Composition 7	Y = 125 T = 135-165	(R) 30-36C	None			1. Titanium, non-magnetic alloy. High strength bolting for use with titanium components such as titanium fire pumps and titanium piping. 2. Commercial equivalent is ASTM F 468 Alloy Ti 5 ELI which is slightly lower strength which is marked "F 468GT."
As above Nut	MIL-T-9047 Composition 7	P = 135	(R) 30C min	None			1. Titanium nuts for use with alloy T7 bolts. 2. Commercial equivalent is ASTM F 467 Alloy Ti 5 ELI which is slightly lower strength and marked "F467GT."

Figure 075-3-1 FASTENER MATERIAL CHARACTERISTICS (CHEMICAL AND PHYSICAL), IDENTIFICATION MARKINGS AND SUGGESTED USE (cont.)

Material and Type of Fastener	Material Specification, Grade, Type, Class, or Alloy & Condition	Strength in KSI – Yield (Y) Tensile (T) Proof (P)	Hardness, Brinell (B) or Rockwell (R)	Coating Type Permitted (Note: may limit useable temperature)	Temp. Limits for Fastener	Identification Marking	Suggested Usage for Threaded Fasteners
LEGEND: A – Machined from annealed or solution annealed stock. CW – Headed and rolled from annealed stock. AF – Headed and rolled from annealed stock and then reannealed. H – Hardened and tempered at 1050°F (565°C) minimum. AH – Solution annealed and age hardened after forming. HT – Hardened and tempered at 525°F (247°C) minimum. * – Fastener Size (Nominal Diameter in inches)							
NOTES: 1. Many existing fasteners on ships do not have grade markings. Fasteners are often marked only if it is a requirement of the specification or the purchase order. Fasteners not marked that have provided satisfactory service should not be arbitrarily replaced. When installing replacement fasteners, check drawings, allowance part lists, or other technical documents for material requirements. Do not rely solely on the markings of an existing fastener to select a replacement fastener since the existing fasteners may have been mixed up during previous maintenance activities. 2. The presence of a self-locking element on a nut, bolt, or screw is usually obvious prior to installation. However, six raised or depressed dots on the head are used to identify a self-locking element on bolts and screws. 3. Austenitic corrosion-resistant steels may be slightly magnetic and can become more magnetic if they are work-hardened.							

Figure 075-3-1 FASTENER MATERIAL CHARACTERISTICS (CHEMICAL AND PHYSICAL), IDENTIFICATION MARKINGS AND SUGGESTED USE (cont.)

075-3.4 ISSUES AFFECTING MATERIAL SELECTION

075-3.4.1 CORROSION. Shipboard environments present two basic fastener corrosion problems: (1) oxidation of carbon steel and alloy steel fasteners which are located in humid atmospheres or periodically wetted, and (2) galvanic corrosion, which results when dissimilar metals are electrically coupled to each other in the presence of moisture.

075-3.4.1.1 Oxidation. The surfaces of most unprotected metals are subject to oxidation. When oxidation occurs on steel, it is called rusting. Although other metals such as aluminum or brass do not rust like steel, they do oxidize. The higher the humidity, the temperature, or both, the faster and more severe the oxidation. This is why oxidation is more likely to occur in machinery spaces and fan rooms than in living spaces. Carbon and alloy steel fasteners are more susceptible to oxidation (rusting) than other materials, although aluminum also presents a significant problem. Several coatings are available to improve the oxidation resistance of steel and aluminum fasteners. Some of these coatings are listed in [Table 075-3-1](#).

075-3.4.1.2 Galvanic Corrosion. Any time two different metals are coupled together in a way that permits electric current to flow between them and both are submerged in a fluid that can also conduct electricity, a battery forms and electrons flow through the coupling and the fluid. This flow of electrons causes what is called galvanic corrosion, which attacks the less noble metal or anode (gold is one of the most noble metals with zinc being one of the least noble). How fast this corrosion proceeds depends in part on the voltage difference or "potential" between the two metals and the fluid they are in. The potential between the lead-oxide and lead-antimony plates in sulfuric acid in a car battery is about two volts per cell. For steel and copper plates in seawater, the potential is about 0.6 volts per cell.

075-3.4.1.2.1 In the case of zinc and steel in seawater, the zinc is the anode and will corrode, whereas the steel (the cathode, in this case) will not corrode. In many places aboard ship zinc is used as a sacrificial anode to protect steel from corrosion. In the case of steel and bronze in seawater, the steel is the anode and will corrode sacrificially to protect the cathodic bronze. A less commonly recognized example is carbon steel coupled to stainless steel. In this case, the carbon steel is also the anode and will corrode sacrificially to protect the stainless steel,

but at a faster rate than with the bronze, because there is a higher potential between the carbon steel and the stainless steel than between the carbon steel and the bronze.

075-3.4.1.2.2 The extent and rate of corrosion are accelerated if the surface area of the anode is small relative to the area of the cathode, such as in the case of a steel fastener in a nonferrous flange or component. This applies to washers, too. Don't use a carbon steel washer with stainless or non-ferrous fasteners, especially if the fastener assembly is in a nonferrous component. The following paragraphs describe techniques for minimizing galvanic corrosion.

CAUTION

Aluminum is highly reactive and may experience extensive galvanic corrosion when coupled with a fastener of relatively low reactivity. Aluminum structure shall be insulated from non-aluminum fasteners, as discussed in paragraph 075-3.4.1.3.3.

075-3.4.1.3 Design Considerations to Reduce or Eliminate Corrosion.

075-3.4.1.3.1 Low Reactivity Fastener Materials. Using fastener materials that have lower reactivity than the structural materials is the primary approach taken for standard Navy designs. The materials recommended for use with the fasteners in the suggested usage column of [Table 075-3-1](#) either have similar reactivity or are more reactive than the fastener materials. Using a less reactive material for the fastener will result in corrosion of the structure instead of the fastener. Because the surface area of the structure (anode) is usually much larger than the surface of the fastener (cathode), galvanic corrosion of the structure will be insignificant.

075-3.4.1.3.2 Materials for Corrosion Resistance. [Table 075-3-1](#) lists the suggested fastener materials and coating requirements to ensure adequate corrosion resistance, including resistance to galvanic corrosion for various applications and combinations of materials to be joined.

Table 075-3-2 ASTM F 593 STAINLESS STEEL BOLTS, SCREWS AND STUDS

Alloy Group	Alloys*	Normal Condition	Marking	Optional Conditions and Marking	
				Weaker	Stronger
1	304, 305, 384, XM7	Cold Worked	F593C or F593D	(AF) F593A (A) F593B	(SH1) F593A (SH2) F593B (SH2) F593C (SH4) F593D
2	316	(CW)	F593G or F593H	(AF) F593E (A) F593F	(SH1) F593E (SH2) F593F (SH3) F593G (SH3) F593H
3	321, 347	(CW)	F593L or F593M	(AF) F593J (A) F593K	(SH1) F593J (SH2) F593K (SH3) F593L (SH4) F593M
4	430	Annealed	F593N	None	None
5	410, 416 416SE	(H)	F593P		(HT) F593R
6	431	(H)	F593S		(HT) F593T
7	630	(AH)	F593U	None	None

Table 075-3-2 ASTM F 593 STAINLESS STEEL BOLTS, SCREWS AND
STUDS - Continued

Alloy Group	Alloys*	Normal Condition	Marking	Optional Conditions and Marking	
				Weaker	Stronger
A = Machined from annealed stock AF = Headed and rolled from annealed stock and then reannealed CW = Heated and rolled from annealed stock, acquiring a degree of cold work H = Hardened and tempered at 1050°F minimum HT = Hardened and tempered at 525°F minimum SH = Machined from strain hardened stock *Within an alloy group, the alloys listed are considered interchangeable.					

075-3.4.1.3.3 Use of Sealants or Insulators. Insulating material can prevent current from passing between the fastener and the structure in which it is used. Metallic-ceramic coatings on steel fasteners tend to act as an insulator where stainless steel structures are attached with steel fasteners; any break in the coating, however, exposes the steel to accelerated attack that in time will overcome the protective capabilities of the coating. The best approach is never to use a carbon steel fastener in nonferrous structures or components, especially stainless steel. This is one of the worst galvanic combinations and the worst size mix (a large stainless steel mass with a small carbon steel mass). Aluminum structures must be insulated from non-aluminum fasteners. Sleeves, washers, and thread sealant compounds are required to prevent the galvanic corrosion of the aluminum.

075-3.4.2 HYDROGEN EMBRITTLEMENT AND STRESS CORROSION CRACKING. Hydrogen embrittlement and stress corrosion cracking can cause fasteners to fail, first by cracking, then by complete breakage. Both problems attack the fastener at the grain boundaries of the metal and either initiate a crack or expand an existing one. Some metals are more susceptible to these problems than others. The best way to prevent this kind of failure is to avoid doing anything to the fastener that is known to cause the problem. Be especially alert to the precautions given in paragraph 075-3.4.2.1.

075-3.4.2.1 High-Strength Steel Fasteners. Sacrificial metal coating (cadmium, zinc, metallic-ceramic that contains aluminum, and inorganic zinc silicate paints) of high-strength steel fasteners (over 150 ksi tensile strength) for corrosion protection increases their susceptibility to hydrogen embrittlement and the potential for failure. The reaction of these coatings to corrosive environments releases atomic hydrogen which diffuses into the fastener causing the embrittlement. Therefore, zinc or aluminum coated fasteners of a tensile strength greater than 150,000 psi shall not be used in applications in the weather, or where subject to periodic wetting or heavy condensation. Cadmium plated fasteners of this strength shall not be used in the weather or subject to periodic wetting. If corrosion resistant fasteners of sufficient strength cannot be used, uncoated (after preservative removal) or black oxide coated steel fasteners may be installed when protected in the following manner.

Table 075-3-3 STRENGTH AND IDENTIFICATION MARKINGS FOR 400
SERIES STAINLESS STEEL FASTENERS

Alloy & Condition	Strength		Marking
	Yield	Tensile	
ASTM F 593			
410 H, 416 H	90 ksi	110-140 ksi	F593P, F594P*
416Se H			

**Table 075-3-3 STRENGTH AND IDENTIFICATION MARKINGS FOR 400
SERIES STAINLESS STEEL FASTENERS - Continued**

Alloy & Condition	Strength		Marking
	Yield	Tensile	
410HT, 416HT 416Se HT	120 ksi	160-190 ksi	F593R, F594R*
MIL-S-1222 Rev G 410 T 416 T	95 ksi	125-150 ksi	410, B6, 6* 416, B6F, 6F*
410 H 416 H	135 ksi	180-220 ksi	410, B6, 6* 410, B6F, 6F*
MIL-S-1222 Rev H 410 H 416 H 416Se H	95 ksi	125-150 ksi	410, 410H 416, 416 H 416Se, 416Se H
410 HT 416 HT 416Se HT	135 ksi	180-220 ksi	410 HT, 410 416 HT, 416 416Se HT, 416Se

* Marking is for nuts.

Table 075-3-4 SOURCES FOR MIL-S-1222 FASTENER PART NUMBERS

Document Number	Fastener Type	Material ASTM Guide	Coating
MS16206	Bolt, hex-head regular, semi-finished, UNC-2A	Aluminum 6061	Anodized
MS16208	Bolt, hex-head regular, semi-finished, UNC-2A	300 series CRES	None
MS16285	Nut, hex-head regular, semi-finished, UNC-2B and 8N-2B	Carbon-moly steel	None
MS16285	Nut, hex head regular, semi-finished, UNC-2B and 8N-2B	Carbon-moly steel	None

- a. Dip fastener in polysulfide sealant (MIL-S-81733 or MIL-S-8802, Class I and II) or paint with polysulfide sealant. Be sure area under head is coated. Install fastener and make sure entire head is coated with sealant.
- b. After sealant dries, paint with a coat of epoxy primer (MIL-P-24441/1 or equivalent).
- c. After epoxy primer dries it is permissible to coat with the same paint as used on adjacent equipment.

WARNING

Do not use ASTM A 354 grade BD or SAE grade 8 high-strength fasteners that have been treated with zinc or metallic-ceramic coatings for any ship-board applications where they would be subjected to submergence, wet spaces, or the weather: these coatings increase the susceptibility of the fasteners to embrittlement. Zinc- or cadmium-coated steel fasteners shall not be used for applications above 400°F: these coatings may cause hydrogen embrittlement. Especially avoid mixing zinc- and cadmium-coated nuts, bolts, or washers at temperatures above 300°F: the zinc and cadmium will melt and mix. The resulting mixture is known to cause intergranular cracking, with subsequent failure of the fasteners in a short time. Failure of fasteners as described above can result in serious injury to personnel and damage to equipment. Cadmium or zinc is not permitted where it would be in contact with fuel oil, lubricating oil, grease, or petroleum-based hydraulic fluid. This restriction does not prohibit the use of cadmium or zinc plated fasteners in locations that are external to these systems if there is no danger of contaminating the working fluid. For example, cadmium or zinc plated fasteners could be safely used as hold down or mounting bolts for a hydraulic control valve since there is no danger of contact between the external fasteners and the fluid inside the valve. Personnel should wash their hands after handling cadmium plated fasteners to avoid ingesting cadmium.

075-3.4.3 COATINGS. Coatings are used for several purposes, primarily for corrosion protection, but also for appearance. In addition, there are antiseize coatings to prevent threads from seizing together either from galling or from harsh environments, and lubricants to assist in reaching the proper preload when tightening the fasteners.

WARNING

The color of a fastener or its coating must never be relied on for selection or identification. Many low strength fasteners of brass, CRES, copper-nickel and silicon bronze are coated with black oxide, nickel, silver, tin, zinc, or cadmium and have a visual appearance similar to higher strength steel fasteners. Use a magnet and other procedures as discussed in paragraph [075-3.4.3.3](#) to ensure that a low strength fastener is not used in applications requiring carbon or alloy steel fasteners.

075-3.4.3.1 Corrosion Protection. Carbon steel and alloy steel fasteners require protective coatings where they are directly exposed to seawater spray, such as on the weather deck or in areas subject to occasional wetting such as passageways or some compartments just off the weather deck. Other areas requiring protective coatings include air intakes, machinery spaces, and bilges. Coated fasteners must not be used in immersion applications. Approved coatings are given in [Table 075-3-1](#).

075-3.4.3.2 Zinc and Cadmium Coatings. Stocked fasteners may or may not be coated. The most common coatings are zinc or cadmium. Cadmium plating emits toxic fumes when exposed to temperatures above 400°F and is not permitted in applications operating at or above 400°F. Because of environmental concerns, particularly in manufacturing, the use of cadmium plated fasteners is being phased out. Substitution of zinc coating for cadmium coating is not permitted for any fastener whose required tensile strength is greater than 150,000 psi. This prohibits substitution of zinc plated socket head cap screws for cadmium plated socket head cap screws. High strength steel zinc plated fasteners are subject to stress corrosion cracking at less than half the stress of similar cadmium coated fasteners. Zinc coated steel fasteners with a tensile strength of 150,000 psi shall be subject to the use limitations identified in paragraph [075-2.4.3.3](#).

075-3.4.3.3 Black Oxide Coated Fasteners. Black oxide coating is one of the most frequently used fastener coatings. Carbon and alloy steel fasteners may be black oxide coated along with many lower strength materials such as brass, corrosion resistant steel (CRES), nickel-copper (monel) and silicon bronze. One must never rely on the appearance of a fastener as a satisfactory indicator of fastener material. A magnet should always be used as a verification tool when installing fasteners. In most cases, a strongly magnetic fastener will be carbon or alloy steel with a higher strength than many feebly magnetic or non-magnetic materials. On the other hand, most corrosion resistant materials are non-magnetic and have lower strengths. A magnet cannot positively identify the material but is a verification tool to be used to supplement fastener identification marks and fastener package identifications.

075-3.4.3.3.1 Black Oxide Coated Brass Threaded Fasteners. Most of the brass fasteners in the supply system are black oxide coated. This presents a potential for improper installation, particularly in place of steel fasteners which may also be black oxide coated. Not only are the brass fasteners of significantly lower strength, but they decrease rapidly in strength at temperatures over 250°F. In October 1990, black oxide coated brass nuts were incorrectly used to repair a steam valve, resulting in a casualty which killed a number of sailors. As a preventive measure, NSN's have been established for shiny brass nuts of the sizes of black oxide coated nuts most likely to pose a hazard due to incorrect substitution aboard ships. See [Table 075-3-5](#) for drawing part numbers and NSN's for replacement shiny brass or nickel-copper (monel) nuts.

075-3.4.3.3.2 Requirements For Use Of Black Oxide Coated Brass Fasteners. To minimize the improper use of black oxide coated brass fasteners the following requirements apply to their use:

- a. Black oxide coated brass fasteners that are currently installed correctly (that is installed in applications that require brass fasteners) do not need to be replaced or have the coating removed.
- b. When black oxide coated brass fasteners are removed for maintenance or new fasteners installed, fasteners 1/4 inch diameter and larger shall either be replaced with shiny brass or have the black oxide removed by mechanical means from one surface. (Black oxide coated brass fasteners being removed and not reinstalled should be properly disposed of or have the coating similarly removed to prevent inappropriate installation at a later time.)
- c. Nickel-copper fasteners may be substituted for black oxide coated brass fasteners.
- d. The number of black oxide coated brass screws, bolts, and studs is too extensive to provide replacements in shiny brass. Therefore when replacing any fastener, a magnet shall be used to check the material of the fastener. Steel is magnetic, brass is not. Some other materials such as CRES are coated with black oxide and are also non-magnetic.
- e. When replacing incorrectly installed black oxide coated brass fasteners, refer to paragraph [075-2.3.3](#) for assistance in determining the proper replacement fasteners.

WARNING

Brass fasteners shall not under any conditions be installed in Level I applications or systems operating at temperatures above 250°F. Because of their lower strength, brass fasteners shall not be substituted for fasteners of another material. Many brass fasteners are black oxide coated and can be mistaken for steel fasteners. A few small diameter brass nuts may also have nickel, tin or silver coatings which can also be mistaken for steel nuts. Always use a magnet for verification when steel fasteners are required.

075-3.4.3.4 Zinc Primer Coating in Accordance with DOD-P-24648. A coating that provides excellent corrosion resistance and at a lower cost than metallic ceramic coatings is inorganic zinc primer in accordance with DOD-P-24648 Type I, Class 1, Composition B. Because it does not require a high temperature bake it has been used to coat self-locking nuts with elastomeric inserts. This coating may be substituted for metallic zinc coating in accordance with [Table 075-3-6](#). Note: Neither this coating or metallic-ceramic coating should be applied to high strength steel bolts or screws with a specified minimum tensile strength greater than 150,000 psi.

Table 075-3-5 REPLACEMENTS FOR BLACK OXIDE COATED THREADED FASTENERS (BRASS HEXAGON NUTS)

Nominal Size	Black Oxide Coated Threaded Fasteners		Replacement Shiny Brass Fasteners	
	NSN	Part Number	New NSN	Cage-14153 Dwg. Part No.
.250-UNC-2B	5310-00-855-1102* 5310-00-939-2653	MS35649-2255** MS51969-1	5310-01-349-4084	02363-1
.312-UNC-2B	5310-00-786-4599 5310-00-903-3996	MS35649-2315** MS51969-2	5310-01-349-4085	02363-2
.375-UNC-2B	5310-00-056-3394 5310-00-903-3994	MS35649-2385** MS51969-3	5310-01-349-4086	02363-3
.500-UNC-2B	5310-00-913-5474	MS51969-5	5310-01-350-2904	02363-4
.625-UNC-2B	5310-00-913-5475	MS51969-7	5310-01-350-2905	02363-5
.750-UNC-2B	5310-00-913-5476	MS51969-8	5310-01-349-4087	02363-6
.875-UNC-2B	5310-00-913-5473	MS51969-9	5310-01-349-4088	02363-7
1.00-UNC-2B	5310-00-905-2669	MS51969-10	5310-01-349-4089	02363-8
.312-UNF-2B	5310-00-903-3991	MS51970-1	5310-01-349-4090	02362-1
			Replacement Ni-Cu Fastener	
			New NSN	Specification
1.125-UNC-2B	5310-00-436-7218	MS51969-11	5310-00-272-5705	MIL-S-1222, Type I, Style A or B

*Part numbers with "B", "N", "S", and "T" suffixes should also not be used.
 "B" = Black oxide
 "N" = Nickel plated
 "S" = Silver plated
 "T" = Tin plated
 **Also stocked under NSN's 5310-00-167-1371 and 5310-00-141-3034.

075-3.4.3.4.1 Self-locking Nuts with DOD-P-24648 Coating. These nuts have been installed on a number of ships. The nuts are a MS17829 configuration with the inorganic zinc coating rather than cadmium or zinc electro-plating. NAVSEA Dwg 53711-180-6931697 covers these nuts. Part numbers are 6931697 plus the dash number with the dash number being the same as for the equivalent size MS17829 nut. See use restrictions in [Table 075-3-6](#).

075-3.4.3.5 Metallic-Ceramic Coated Fasteners. Metallic-ceramic coated bolts (screws) and nuts have been used in a number of shipboard applications. The metallic-ceramic coating is usually in accordance with MIL-C-81751, Type I, Class 4. While the metallic ceramic coated fasteners have superior corrosion resistance, these fasteners do have a high cost and some associated problems as identified below:

- a. The required coating thickness cannot be applied within the conventional coating thickness allowance and therefore fastener threads have to be manufactured undersize. The Navy does not procure in large enough quantities to make this economical so producers charge high prices and wait months before interrupting their standard production. This places the cost above and availability below other fastener material and coating combinations.
- b. Metallic-ceramic coating fasteners are subject to chipping due to rough handling. If the coating is chipped, the location chipped is subject to accelerated corrosion.
- c. Reports have been received that it is often impossible to disassemble the metallic-ceramic coated fasteners.
- d. Metallic-ceramic coating should not be used on steel screws or bolts with a tensile strength of 150,000 psi or greater due to concerns for hydrogen embrittlement and stress corrosion cracking.

Because of the problems identified above, the supply system has been advised not to procure metallic-ceramic coated fasteners in the future.

075-3.4.3.5.1 Approved Substitutes for Metallic-Ceramic Coated Fasteners. There is no single substitute that can be used as a substitute for metallic-ceramic coatings in all applications. For some applications, corrosion resistant fastener materials can be used more economically and provide better corrosion resistance. Sealants and painting of uncoated fasteners provide even lower cost alternatives where corrosion is not severe. [Table 075-3-6](#) lists acceptable replacements using noncorrosion resistant materials. For corrosion resistant substitutes or when additional guidance is needed, contact NAVSEA or the Life Cycle Manager for the equipment (see [Section 075-3.7](#)). For any metallic-ceramic coated fasteners for nuclear application or with a HX stock designation, identify the fasteners and contact SEA 08 for guidance.

075-3.5 HIGH-TEMPERATURE FASTENERS

075-3.5.1 As discussed in the paragraph on relaxation at high temperatures, fasteners tend to stretch with time in the direction of the applied load. This causes them to lose their preload. Most steel fasteners must not be used where they will be subjected to temperatures above 650°F. Oxidation also will occur on the surface of unprotected metals at elevated temperatures, even though no moisture is present. Never use zinc-, cadmium-, or aluminum-coated high-strength fasteners in high-temperature applications. The fastener may crack due to hydrogen embrittlement as discussed in paragraph [075-3.4.2](#). Use specially alloyed steels designed to resist high-temperature oxidation and high-temperature relaxation in these applications. Use ASTM A 193 grade B16 alloy steel externally threaded fasteners and ASTM A 194 grade 7 nuts at temperatures up to 1,000°F. If corrosion is a problem, ASTM A 453 grade 660 stainless steel fasteners provide corrosion resistance up to 1,200°F. If coated fasteners are unavoidable in high temperatures, take into account the temperature resistance of the coating. See [Table 075-3-1](#) for temperature limitations on specific fasteners.

CAUTION

When selecting replacement fasteners, do not rely on markings of the existing fastener. The wrong fastener may have been installed in the past. Review technical documentation, including the APL since in some cases the APL's have been updated while other technical documentation has not been updated. The absence of identification markings on a threaded fastener does not necessarily preclude its use as some fastener specifications do not require identification marking. However, the absence of a marking is a "red flag" that additional verification, such as proper identification on the package or box, is needed before installation.

075-3.6 SUITABLE USES FOR THREADED FASTENERS

075-3.6.1 Suitable uses and restrictions for threaded fasteners are listed in [Table 075-3-1](#). These suitable uses are for guidance only when the type of fastener is not specified. When drawings, technical manuals, APL's, etc. specify a fastener for an application, the specified fastener shall be installed and [Table 075-3-1](#) shall not be used. When technical documentation identifies a fastener in conflict with the guidance in [Table 075-3-1](#) the form in [Table 075-3-7](#) may be used as identified in paragraph [075-3.7](#) to advise the Life Cycle Manager of a potential problem.

Table 075-3-6 ALTERNATIVES TO METALLIC CERAMIC COATED FASTENERS

Current Fastener Materials	Service Conditions			Acceptable Alternatives
	Strength (ksi)	Temperature	Location	
BOLTS - ASTM A 193 GR B16	Tensile-125 Yield-105	1000°F Max	High Temperature Piping Systems	ASTM A 193 GR B16 - UNCOATED
BOLTS - ASTM A 193 GR B7		775°F Max	(Steam Steam Drains, etc.)	ASTM A 193 GR B16 or B7 - UNCOATED
NUTS - ASTM A 194 GR 7	Proof Hex - 150 Heavy Hex - 175	1000°F Max		ASTM A 194 GR 7 - UNCOATED
NUTS - ASTM A 194 GR 4		875°F Max		ASTM A 194 GR 7 or GR 4 - UNCOATED
BOLTS - SAE J429 GR 8 or ASTM A 354 GR BD	Tensile - 150 Yield - 130	650°F Max		Foundations and Equipment Located in the weather
NUTS - SAE J995 GR 8	Proof - 150		For Bilges, & Wet Spaces as approved by NAVSEA	SAE J995 or ASTM A 563, GR DH UN-COATED (Install using same procedure as above.)
SELF-LOCKING NUTS - MS17829 (Note 3)	Proof - 150	120°F Max		Coat with Zinc primer IAW DOD-P-24648, (see 075-3.4.3.4.1 & Note 4)
SAE J429 GR 5 and J995 GR 5, ASTM A 449, A 354 GR BC and A563 GR C	Less than 150 Tensile or Proof	120°F Max		Zinc primer IAW DOD-P-24648, Type I, Class 1, Composition B. (See Note 4)

1. Polysulfide sealants contain solvents and must be applied in well ventilated areas. Avoid prolonged contact with the skin, contact with open breaks in the skin and ingestion. Testing to determine suitability for use inside submarines is being conducted. Follow manufacturer's restrictions and Material Safety Data Sheet.

2. Immediately prior to installation, dip fastener in or apply polysulfide sealant with a brush. Install fastener before sealant hardens. After installation, make sure that all exposed surfaces are coated with sealant. After sealant has dried, apply a coat of epoxy polyamide primer, MIL-P-24441/29. Subsequently, coating with same paint as on adjacent surfaces is permissible.

3. Previous use of zinc primer may be shown incorrectly on drawings as metallic ceramic coating.

4. Proper adhesion of the zinc primer requires that the fastener surface be sandblasted to a near white surface. Because of potential outgassing from the primer, usage in many applications is subject to NAVSEA approval.

075-3.7 TELEPHONE NUMBERS AND POINTS OF CONTACT

075-3.7.1 NAVSEA. Contact personnel at NAVSEA are listed below for their areas of responsibility. The telephone number is (703)-602 + Ext. or DSN 332 + Ext. Requests for information or answers to questions concerning fasteners may be forwarded to NAVSEA 03W14 by facsimile transmission using the "Inquiry & Technical Response Record" (Table 075-3-7).

075-3.7.2 DISC. Personnel at DISC (Defense Industrial Supply Center) may also be contacted for assistance. The telephone number is (215)-697 + 2000 or DSN 442 + 2000. Ask for the item manager for the Federal Supply Code listed in Table 075-3-9 or for the Fastener Engineering Division if the item manager cannot provide the needed assistance.

075-3.7.3 NAVICP-M-P (NAVAL INVENTORY CONTROL POINT), FORMERLY SPCC (SHIPS PARTS CONTROL CENTER). Personnel at NAVICP-M-P, Code 8452P, may be contacted for assistance in the ordering of Level I/Subsafe fasteners. The number is (717)-790-2073 or DSN 430- 2073. NAVICP-M-P also publishes the **Level I/Subsafe Stock Program Catalog** (NAVSEA 0948-LP-103-6010) which provides ready identification of Level I/Subsafe fasteners by using activities. The catalog lists materials in the LI/SS Stock Program by noun name and shows the applicable National Stock Number (NSN) or Navy Item Control Number (NICN) to be used in requisitioning material from NAVICP (Mechanicsburg, PA) via normal supply channels. The items in the catalog are grouped by commodity for ease of use.

Table 075-3-7 INQUIRY AND TECHNICAL RESPONSE RECORD

To	From	Inquiry & Technical Response Record
		NAVSEA 03W14, FASTENERS Fax: (703) 602-4746 Phone: (703) 602-1596 DSN: 332 + ext. Date: _____ Engineer: _____ Supervisor: _____
		Activity: _____ Contact: _____ Date: _____ Phone: _____ Extension: _____ DSN: _____ Fax: _____

Ship _____ System _____

Applicable Drawings, Technical Manual _____

Describe Question or Problem _____

(attach additional pages if necessary)

NAVSEA REPLY: Cognizant Technical Code _____ Phone _____

Tech Code Engineer _____ Tech Code Comments _____

Guidance provided by SEA 03W14 _____

How provided: Verbal _____ Fax _____ Other _____

Table 075-3-8 NAVSEA CONTACTS

Area of Responsibility	Code	Ext.
Fastener Point of Contact General and Standardization Requirements Socket Head Cap Screws	03W14	1596
NSTM Chapter 075, Fasteners to Non-NAVSEA standards	03W14	1596
Mil. Spec. MIL-S-1222 Metallurgy/Materials	03ME	0205
PC-BOLTS Fastener Torque Computer Program	SEA92T	8097

Table 075-3-9 FEDERAL SUPPLY CODES FOR FASTENERS

FSC	Item
5305	Screws (Plain & Self-locking)
5306	Bolts
5307	Studs
5310	Nuts & Washers
5340	Threaded Inserts

SECTION 4.

FASTENER TIGHTENING

075-4.1 GENERAL

075-4.1.1 Tightening a threaded fastener means turning a nut on a bolt or stud or turning a capscrew in a tapped hole until you achieve the required clamping force. Installation specifications usually call for a particular torque for each fastener or group of fasteners. Although installation specifications usually call for a particular torque for each fastener or group of fasteners, it is not the torque that is important, it is the clamping force that is developed by that torque that matters. The clamping force required depends on the particular application. Some applications, such as swing-leg pipe hangers or clevises, may require no clamping force, and in fact, may specify that the fastener be loose. Other applications, such as turbine casing fasteners or hull integrity or main steam flange fasteners, may require clamping forces that stress the fastener almost to its yield point. The order in which each fastener is tightened may also be specified. Fastener tightening procedures developed by the shipbuilder or the equipment manufacturer should be provided for all critical systems or joints (i.e. main and auxiliary steam, hydraulic, high pressure air and other gases, high pressure feed, condensate and drain, diesel engine hold-down bolts, main bearing cap bolts). In other words, fastener torques or tightening procedures should be provided for any pressure containing system where release of the entrapped fluid or gas will have a detrimental effect on safety of personnel or the ability of the ship to accomplish its mission or any bolted flange or joint whose failure might cause injury to ship's personnel or damage to equipment thus preventing or reducing the ability of the ship to accomplish its mission. Where tightening instructions are not provided, recommended torque values and the tightening procedures specified herein may be used.

This section will discuss the following:

- a. Tightening sequence
- b. Preload
- c. Relaxation
- d. Methods of establishing preload

075-4.2 TIGHTENING SEQUENCE

075-4.2.1 If more than one fastener is used in a joint, determine the proper tightening sequence for each fastener. More than one piece of expensive equipment has been cracked or warped because the mechanic failed to follow this rule. Installation specifications should specify the tightening sequence for each assembly using two or more fasteners. If the sequence is not specified, follow the applicable guide shown in [Figure 075-4-1](#).

075-4.3 PRELOAD

075-4.3.1 PRELOAD THEORY. Think of a threaded fastener being used to hold two flanges together. The nut has been tightened, or snugged up, just enough to hold the flanges in contact with each other. This fastener would be considered to have no preload. If you tried to pull the flanges apart, the fastener would feel the force that you applied. Now, tighten the nut so that the clamping force it is applying to the flanges is greater than the force you applied by pulling on them. You have now preloaded the fastener and it will not feel the force you are applying. The amount of preload a fastener needs is usually considered to be an amount somewhat larger than the largest force that the fastener will experience in service.

075-4.3.1.1 A good example to help in visualizing the mechanism of preload is given by a valve and valve spring assembly in a car engine. The valve spring, the two "flanges" in this case, is compressed to about 150 pounds. The nut (valve keeper) is now installed on the end of the valve stem (bolt.) The valve stem has now been preloaded to 150 pounds. Now push on the valve stem with a 149 pound force. The valve will not open and the valve stem will not feel any reduction in load. However, if you push with a force of 151 pounds, the valve will begin to open since you have exceeded the preload. At this point the valve stem has no tensile force acting on it. The force went from 150 pounds to zero as soon as the valve lifted off its seat.

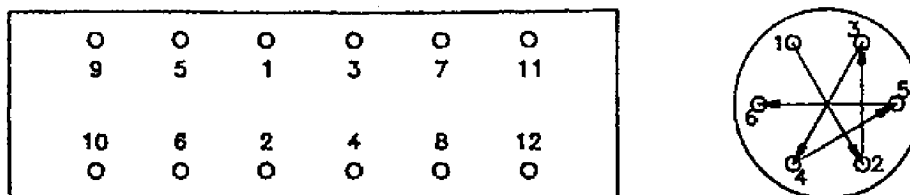

Figure 075-4-1 Tightening Sequence

075-4.3.2 PURPOSE OF PRELOAD. There are two basic reasons to apply preload to a fastener: (1) to reduce the tendency for the fastener to loosen in service and (2) to improve the fastener fatigue life.

075-4.3.2.1 Preventing Loosening. See paragraph [075-5.2](#) for a discussion on the use of preload to prevent loosening.

075-4.3.2.2 Improving Fastener Fatigue Life. With the possible exception of loss of the fastener due to loosening, the primary cause of fastener failure in service is breakage due to fatigue. Any application of a significant load to a part that causes stress levels in that part to reach 50 percent of yield or more causes some fatigue damage. Repeated (cyclic) application of that load will result in an accumulation of fatigue damage that will eventually cause a crack to develop where the stresses are highest. As the cyclic load continues to be applied, the crack grows and the part eventually breaks. If the fastener is torqued to the point where its tensile stress is above the operating stresses, however, the fastener will pass through only a small fatigue cycle. Some materials resist the accumulation of fatigue damage better than others. For example, mild steel has very good fatigue life while the fatigue life of copper and aluminum is relatively poor.

075-4.3.2.2.1 Influence of Cyclic Stresses. A piece of wire, tubing, or flatbar, a nail, or a bolt will all break if you bend them back and forth several times. They will also break if you don't actually bend them, but just flex them back and forth often enough or vibrate them. Likewise, the main bearing cap bolt on an engine will break if it is not properly tightened and the engine is run hard. In this case, the stresses in the bolt are not bending stresses but tensile stresses. It doesn't make any difference what kind of stresses they are; if they are high enough and cycled on and off - or worse, back and forth - enough times, the part will break. The dangerous thing about fatigue damage is that no nondestructive testing (NDT) technique can tell you how much has occurred. A part can be one load cycle from developing a crack and you can't detect it.

075-4.3.2.2.2 Sources of Cyclic Stress. Now think about what happens to the main bearing cap bolt. If it is just snugged up, each time one of the pistons pushes down on the crank the bolt is loaded up with a high tensile load. If the cap bolt is tightened so that its tensile load (preload) is greater than the operating loads from the pistons, however, the bolt will experience no significant load changes and fatigue damage will be minimal. The same thing happens to most of the equipment on board ship. As the ship works in the seaway and the equipment and piping on board the ship vibrate, shake, and are exposed to thermal expansion loads and pressure changes, these changes and actions can potentially subject the fasteners that hold the equipment and piping in place to changes in loading. Two especially critical applications are diesel engine hold-down bolts and main steam line flange bolts. The diesel engine hold-down bolts are affected by vibration and the main steam line flange bolts experience increased loading due to thermal expansion loads and pressure changes.

075-4.3.2.2.3 Determining Design Torque. When a bolted joint is designed, several factors must be considered before determining the preload required, bolt size, and number of bolts to be used. These factors include, but are not limited to, such things as creep relaxation, thermal effects, as well as in-service loads. Many of these factors can not be predicted with a high degree of certainty and each may vary from application to application. In addition, there can be as much as a 75% variation between the actual preload present after application of the specified torque and the calculated preload for that torque. Therefore, the bolt torque that should be listed in the equipment technical manual or on the applicable drawing is one that will provide the minimum required preload (plus a factor of safety if it is considered a critical joint) under the worst predicated circumstances without overstressing the fastener. The size and number of fasteners may be increased to ensure that no one bolt will be overstressed.

075-4.3.2.2.4 Recommended Torque Values. Use the table of recommended torque values ([Table 075-4-1](#)) when you can't find the equipment installation specifications and the manuals and/or drawings do not identify the torque values. The equipment designer uses a similar table to select the fastener. This means that if you tighten the fastener to the maximum recommended torque from [Table 075-4-1](#), you will probably have enough preload

to hold until you can get a copy of the technical manual or the applicable drawing and make any necessary corrections. The torques in [Table 075-4-1](#) have been designed to produce a tensile stress in the fasteners of 60 percent of the minimum yield strength of the material. The following requirements also apply to [Table 075-4-1](#).

- a. These values apply to nuts on stud bolts and through bolts only.
- b. These values are based on lubricated fasteners only.
- c. When using self-locking fasteners, measure the prevailing torque that exists before the bearing surfaces contact. Add this prevailing torque to the torque values in the table.
- d. These values are intended to be used with metal-to-metal joints or joints with hard gaskets such as these made of material manufactured to MIL-G-24696, **Gasket, Sheet, Non-Asbestos**, which are 1/8 inch thick or less. They are also suitable for use with steel flanges using spiral-wound gaskets, which have a compression control ring or recess. See paragraph [075-4.5.1.6](#) for more detail on establishing adequate preload in flange joints with spiral-wound gaskets.
- e. These values are usually too high for soft (rubber) gasketed joints or joints with plastic insulator elements.
- f. If these torques do not produce the desired results (a leak-free or rigid joint), inspect for damaged threads, dirt, or metal chips in threads, bent studs, or warped mating surfaces.
- g. For through bolts, always hold the bolt head and tighten the nut, never the other way around.
- h. [Table 075-4-1](#) is based on the assumption that both of the mating thread components are of materials of nearly equal strength. When the material of the internally threaded component is of lower strength than the externally threaded component, which is common, a reduced torque must be used or inserts installed in the weaker material. The required torque in such cases should be listed on component drawings or in component technical manuals. When this information is not specified, the torque limits in [Table 075-4-2](#) should be used as guidance. Regardless of the length of insert, do not use a torque value for a material with a greater strength than the fastener actually used.

075-4.3.3 DETERMINING PROPER PRELOAD. The proper preload has been determined for a joint when the clamping force specified for each fastener exceeds the maximum load that will be applied to that fastener during any design operating condition. It bears repeating that it is not the torque being applied to a fastener that is important, it is the clamping force that results from that torque that is important; the torque is only a means to an end. It doesn't do much good to apply 1000 foot-pounds of torque to a rusty fastener if only 50 foot-pounds of clamping force ever makes it to the equipment because it takes the other 950 foot-pounds to overcome the forces due to the presence of rust.

Table 075-4-1 MAXIMUM RECOMMENDED TORQUE VALUES

Bolt or Capscrew Nominal Diameter	Thread Size	Minimum Yield Strengths				
		30,000 lb/in ²	65,000 lb/in ²	85,000 lb/in ²	105,000 lb/in ²	130,000 lb/in ²
.250	20 UNC	17 in-lbs	37 in-lbs	49 in-lbs	60 in-lbs	74 in-lbs
	28 UNF	20 in-lbs	43 in-lbs	56 in-lbs	69 in-lbs	85 in-lbs
.3125	18 UNC	35 in-lbs	77 in-lbs	100 in-lbs	124 in-lbs	153 in-lbs
	24 UNF	39 in-lbs	85 in-lbs	111 in-lbs	137 in-lbs	170 in-lbs
.375	16 UNC	63 in-lbs	11 ft-lbs	15 ft-lbs	18 ft-lbs	23 ft-lbs
	24 UNF	71 in-lbs	13 ft-lbs	17 ft-lbs	21 ft-lbs	26 ft-lbs
.4375	14 UNC	100 in-lbs	18 ft-lbs	24 ft-lbs	29 ft-lbs	36 ft-lbs
	20 UNF	112 in-lbs	20 ft-lbs	26 ft-lbs	33 ft-lbs	41 ft-lbs
.500	13 UNC	13 ft-lbs	28 ft-lbs	36 ft-lbs	45 ft-lbs	55 ft-lbs
	20 UNF	14 ft-lbs	31 ft-lbs	41 ft-lbs	50 ft-lbs	62 ft-lbs
.5625	12 UNC	18 ft-lbs	40 ft-lbs	52 ft-lbs	64 ft-lbs	80 ft-lbs
	18 UNF	21 ft-lbs	45 ft-lbs	58 ft-lbs	72 ft-lbs	89 ft-lbs
.625	11 UNC	25 ft-lbs	55 ft-lbs	72 ft-lbs	89 ft-lbs	110 ft-lbs
	18 UNF	29 ft-lbs	62 ft-lbs	82 ft-lbs	101 ft-lbs	125 ft-lbs
.750	10 UNC	45 ft-lbs	98 ft-lbs	128 ft-lbs	158 ft-lbs	195 ft-lbs
	16 UNF	50 ft-lbs	109 ft-lbs	143 ft-lbs	176 ft-lbs	218 ft-lbs
.875	9 UNC	73 ft-lbs	158 ft-lbs	206 ft-lbs	255 ft-lbs	315 ft-lbs
	14 UNF	80 ft-lbs	174 ft-lbs	227 ft-lbs	281 ft-lbs	347 ft-lbs
1.000	8 UNC	109 ft-lbs	236 ft-lbs	309 ft-lbs	382 ft-lbs	473 ft-lbs
	12 UNF	119 ft-lbs	259 ft-lbs	338 ft-lbs	418 ft-lbs	517 ft-lbs
1.125	7 UNC	155 ft-lbs	335 ft-lbs	438 ft-lbs	541 ft-lbs	670 ft-lbs
	12 UNF	173 ft-lbs	376 ft-lbs	491 ft-lbs	607 ft-lbs	751 ft-lbs
1.250	7 UNC	218 ft-lbs	472 ft-lbs	618 ft-lbs	763 ft-lbs	945 ft-lbs
	12 UNF	241 ft-lbs	523 ft-lbs	684 ft-lbs	845 ft-lbs	1046 ft-lbs
1.375	6 UNC	286 ft-lbs	619 ft-lbs	810 ft-lbs	1001 ft-lbs	1239 ft-lbs
	12 UNF	325 ft-lbs	705 ft-lbs	922 ft-lbs	1139 ft-lbs	1410 ft-lbs
1.500	6 UNC	379 ft-lbs	822 ft-lbs	1075 ft-lbs	1328 ft-lbs	1644 ft-lbs
	12 UNF	427 ft-lbs	925 ft-lbs	1209 ft-lbs	1494 ft-lbs	1850 ft-lbs

*Maximum recommended torque will develop approximately 60 percent of the minimum yield load for CRES and alloy steel fasteners assuming a torque coefficient of 0.12 which is typical for well lubricated installations.
Fastener loads were determined by multiplying the minimum yield strengths, listed in the table, by the Tensile Stress Area (A^s) listed in ASME B1.1.

Table 075-4-1 MAXIMUM RECOMMENDED TORQUE VALUES - Continued

Bolt or Capscrew Nominal Diameter	Thread Size	Minimum Yield Strengths				
		30,000 lb/in ²	65,000 lb/in ²	85,000 lb/in ²	105,000 lb/in ²	130,000 lb/in ²
<p>Example: For 1/4 (0.250) inch, Grade 8, Alloy Steel Fastener, with UNC threads; Y = Minimum Yield Strength = 130 ksi (from Table 075-3-1) D = Nominal Diameter = 0.250 A_s = Tensile Stress Area = 0.0318 (from ASME B1.1) K = Torque coefficient = 0.12 T = Torque (inch pounds) Maximum Clamping Load = Y * A_s = 130,000 * 0.0318 = 4134 pounds Recommended Clamping Load = 60% of 4134 pounds = 2480 pounds T = Recommended Clamping Load * K * D = 2480 pounds * 0.12 * 0.250 inches = 74.4 inch-pounds (rounded to 74 inch-pounds in table)</p>						

Table 075-4-2 TORQUE LIMITS FOR FASTENERS SCREWED INTO LOW SHEAR STRENGTH MATERIAL

Shear Strength of Material	Typical Material	Insert Length in Nominal Diameters	Use Torque Values From Table 075-4-1 Columns for Applicable Materials as Indicated Below (Min Yield KSI)
20,000	Cast Aluminum Alloys such as 356-T6	No Inserts*	30
		1	65
		1-1/2	85
		2	130
30,000	Aluminum 6061-T6	No Inserts**	65
		1	85
		1-1/2	130
		2	130
40,000	Aluminum 2014 (T4, T6) 2024 (T351, T4, T6)	No Inserts*	65
		1	85
		1-1/2	130
		2	130

*Shipbuilding specifications usually require inserts in all aluminum alloys.
 Values for no insert conditions are based on at least 1 Diameter length thread engagement.
 **Use 80% of the values listed for the 65 KSI column.

075-4.3.3.1 Determining Design Operating Loads. The equipment designers take all loads such as pressure, mechanical, startup and shutdown, thermal expansion, lack of lubrication, or HI shock into account and determine the worst case combination. They then convert this load into individual fastener loads that are used to size the fasteners.

075-4.3.3.2 Determining Torque Requirements. After sizing the fasteners, each individual fastener load is usually converted into torque, which is then specified as the designed torque requirement for that fastener. For some applications, achieving a more precise clamping force (preload) is important enough to require more precise tightening methods. A good example would be turbine casing bolts, which require a combination of initial torque and a specified turn-of-nut (one or two flats, for example) (see paragraph [075-4.5.2](#)).

075-4.4 RELAXATION

075-4.4.1 General. Once you get a fastener tightened properly you would like it to stay that way. That is not what happens with nuts and bolts, unfortunately, because as time passes they tend to lose some of their preload. This loss of preload, or the fastener's tendency to relax in doing its job of holding parts together, is called relaxation. Relaxation has two significantly different phases or stages: initial and long term.

075-4.4.2 INITIAL RELAXATION. Initial relaxation starts as you tighten the fastener and is completed in a few hours. The threads of the fastener and its washers and bearing surfaces work their way closer together, gaskets creep, and equipment flanges seat. In the past, it was standard practice to retorque head bolts on an engine because it took a while for the gasket to seat and reach its initial compressed state. Current engines use different gasket material and start out with higher torques so this retorquing is less important. Be sure to carefully follow the engine manufacturer's instructions concerning retorquing of head bolts. In the event that you are unable to locate the manufacturer's instructions, the following general guidance may be used for preloading operations: (1)

bring the head bolts up to within 10 foot pounds of the final torque value, (2) give the fasteners time to relax while working on something else for about an hour, (3) then torque the fasteners to the correct value. Retorque fasteners in steam pipe joints or other hot systems to the required torque value following the first hot operating cycle.

075-4.4.3 TORSIONAL RELAXATION. High torsional stresses build up in a fastener as it is tightened. These torsional stresses relax with time, however, after the tightening operation has been completed. A large part of this relaxation occurs immediately after the wrench is removed. Most of the remaining torsional stress relaxes in a few days. In the past, there have been recommendations to back off slightly on the nut after it has been tightened to relieve the torsional stress in the belief that this would make more strength available for tension loads. Tests have shown, however, that this initial torsional stress takes care of itself, with some of it being converted into desirable tension or preload stress and most of the rest relaxing on its own. What torsional stresses remain are not harmful, so don't try to remove them.

075-4.4.4 LONG TERM RELAXATION. Long-term relaxation, as its name implies, occurs over several days or several years and causes a fastener to gradually lose its preload. There are two major causes of this long-term loss of fastener preload: stress relaxation and vibration relaxation.

075-4.4.4.1 Stress Relaxation. Long-term relaxation, other than that caused by vibration, is not usually a problem for systems operating below 600°F. As temperatures rise, however, a phenomenon called stress relaxation comes into play. Stress relaxation is the tendency of a highly loaded fastener to lose its preload over time when subjected to high temperatures. This effect of temperature on a loaded fastener is sometimes referred to as high-temperature creep. Some creep, and the accompanying stress relaxation, occurs at just about any temperature, but the rate of relaxation is usually too slow to be of concern in most ambient and moderate temperature applications. Stress relaxation is a major concern where the fastener is subjected to higher temperatures. It becomes significant as operating temperatures rise above 600°F. Since some fastener materials are more susceptible to high-temperature creep than others, be careful to use the proper fasteners for high-temperature applications. The system documentation will specify what fasteners to use.

075-4.4.4.2 Vibration Relaxation. Loosening of fasteners due to vibration where the nut and bolt actually rotate relative to each other is discussed in paragraph [075-5.1.2](#). Vibration will also cause some loss of preload by other means. This is called vibration relaxation. Vibration feeds energy into a fastener. This energy will cause the various mating surfaces to work into closer contact with each other, sometimes causing actual breakdown of the surfaces. You see evidence of this in the form of a red oxide coating between the moving parts. This is called fretting corrosion. Another visual indication of vibration relaxation is the further compression of gaskets installed between mating flanges. All of these vibration effects can eventually reduce the preload to the point where the fastener can start to rotate as discussed in paragraph [075-5.1.2](#). The best defense against vibration relaxation is the same as that used to prevent the loosening discussed in paragraph [075-5.1.2](#); apply as much preload as the fastener and the joint can tolerate (see [Table 075-4-1](#)). This will make the joint more rigid and reduce its response to the vibration.

075-4.5 Methods of establishing preload

The following methods of establishing preload (listed below in order of increasing accuracy) are discussed in this section:

- a. Torque control
- b. Turn-of-nut control

- c. Torque control combined with turn-of-nut control
- d. Stretch control
- e. Ultrasonic stress control

075-4.5.1 TORQUE CONTROL. The first method of establishing preload is torque control.

075-4.5.1.1 Units of Measurement. Torque, when applied to tightening fasteners, is usually measured in inch-pounds or foot-pounds in U.S. standard units, 1 foot-pound being equal to 12 inch-pounds. You will also see torque expressed in pound-inches or pound-feet, which is the designation preferred in scientific specifications. When metric or the International System (SI) units are involved, put the force before the length, as this is the only acceptable designation. As far as U.S. standard units are concerned, inch-pounds and pound-inches are equivalent, and either term is acceptable when applied to threaded fasteners. The metric systems described below have two different conversion factors that do not vary by tens as you might have expected. This is because the newton-meter system is based on mass and the kilogram-meter system is based on weight.

075-4.5.1.1.1 Metric Units, Newton-Meter. The system of metric units that most nations, the United States included, have adopted is the International System of Units. This system is called SI (from the French *Système International d'Unités*) in all languages. When converting from English units to metric units using conversion tables, look up pound-inches and pound-feet, as these are the defined equivalents of the metric units. The metric equivalent of pound-inches is newton-centimeters ($N * cm$); the equivalent of pound-feet is newton-meters ($N * m$). The metric equivalent of a 175 pound-foot torque wrench is a 230 N-m torque wrench. To convert from pound-feet to newton-meters, multiply the pound-foot value by 1.3558 ($lb-ft * 1.3558 = \text{newton-meters}$). Likewise, to convert from newton-meters to foot-pounds, multiply the newton-meter value by 0.73756 ($\text{newton-meters} * 0.73756 = \text{pound-feet}$). To convert from newton-meters to kilogram-meters, multiply by 0.102.

075-4.5.1.1.2 Metric Units, Kilogram-Meter. Some torque wrenches may be calibrated in kilogram-meters ($kg * m$) and kilogram-centimeters ($kg * cm$). In this system of units, the metric equivalent of pound-inches is kilogram-centimeters ($kg * cm$); the equivalent of pound-feet is kilogram-meters ($kg * m$). In this system, the metric equivalent of a 175 pound-foot torque wrench is a 25 $kg * m$ torque wrench. To convert from pound-feet to kilogram-meters, multiply the pound-foot value by 0.1383 ($lb-ft * 0.1383 = \text{kilogram-meters}$). Likewise, to convert from kilogram-meters to foot-pounds, multiply the kilogram-meter value by 7.233 ($\text{kilogram-meters} * 7.233 = \text{pound-feet}$). To convert from kilogram-meters to newton-meters, multiply by 9.81.

075-4.5.1.2 Determining Required Torque. As discussed in the introduction to [Section 5](#) on threadlocking, the thread on a nut is simply a wedge formed into a spiral that you drive under the thread on the bolt with a wrench in an attempt to stretch the bolt. The main problem is that most of the torque goes into overcoming friction with very little left over to pull on (stretch) the bolt. There is a tremendous variation in the surface condition of the threads, and the nut and equipment bearing surfaces. Some are rusty, some rough, and some metals tend to gall. The properties of the lubricants used on threads also vary.

075-4.5.1.2.1 Prevailing Torque. Prevailing torque is the torque required to rotate one part of an unloaded fastener relative to the other. This can vary from essentially none for a new, clean fastener held in your hand, to significant amounts for self-locking fasteners, to large amounts for fasteners with damaged threads. Regardless of the prevailing torque, the final torque value that you can see on your torque wrench must equal the torque specified for that particular application, plus the prevailing torque that you measured as you turn the nut on the bolt in its unloaded state. Otherwise, the actual clamping force that you achieve will be short by the amount of torque required to overcome the prevailing torque. The torque required to draw two mating surfaces together, such as

that required to draw up cold sprung piping joints, is not prevailing torque. Once the clamping force achieved by the fastener exceeds the force required to bring the joint together, the threshold of preload has been reached, and the nut no longer experiences the draw-up force.

075-4.5.1.2.2 Torque vs. Preload Equation. Many calculations have been made and many experiments conducted to try to determine the proper torque vs preload equation. Under ideal conditions - that is, if the threads are well formed and smooth, if the coating was properly applied, if there is no rust or corrosion, if the spot face on the equipment is true with the hole centerline, and if the bearing surfaces are clean and smooth - the following equation works reasonably well as a first-cut approximation:

$$T = KPD + T_p$$

where:

T is the required torque in inch-pounds.

K is the appropriate overall torque coefficient.

P is the desired preload in pounds.

D is the nominal diameter of the fastener in inches.

T_p is the prevailing torque required to turn the unloaded fastener.

075-4.5.1.2.2.1 The value of K will vary significantly, with 0.2 being used for unlubricated steel and 0.13 used for fasteners with a lubricant such as Fel-Pro C5A. The recommended torque values in [Table 075-4-1](#) were developed using a value of 0.12 for K. If you need to be more precise in establishing the proper preload, you will have to use a more precise equation such as the PC-BOLTS computer program discussed below. If greater accuracy than that produced by torque control is required you may want to use one of the other techniques discussed later in this section for establishing the preload.

075-4.5.1.2.3 PC-Bolts Fastener Torque Computer Program. A computer program, PC-BOLTS, is available for calculating torque, preload, and stresses in threaded fasteners. It can be used on IBM PC's and compatibles. The user's guide is NAVSEA 0900-LP-091-6010, **Description, Design, and Maintenance, Submarine Fastening Criteria for Pressure Containing Systems (Non-Nuclear), Appendix E**. The program is maintained at Submarine Monitoring Maintenance and Support Program Offices (SMMSO) and provides a fast but thorough method of computing torque values where no torque value is specified on the applicable ship's drawings or technical manuals. If you are not in port and you need a more precise method of establishing the proper torque, try radioing the following input data to NAVSEA (See telephone numbers at end of [Section 3](#).)

- a. Bolt or stud material
- b. Bolt or stud diameter
- c. Bolt or stud thread series
- d. Nut material
- e. Clamped material (the flange material)
- f. Set end material (for capscrew or stud in blind hole)
- g. Lubricant used
- h. Drawing number and joint designation (if available)

Request that NAVSEA run the program and radio back the results.

075-4.5.1.3 Applying Torque to a Fastener. If a bolt is located so that its centerline is horizontal and a wrench with a perfectly straight, 1-foot-long handle is placed on the bolt head so that the wrench handle is also horizontal, and a 1-pound weight is hung from the end of the handle, 1 foot-pound of torque is being applied to the bolt. If the wrench handle is hanging straight down, no torque is being applied. To make the example a little more complicated but to make a point, if the wrench handle is horizontal but bent so that it is at a 45-degree angle to the centerline of the bolt, 0.707 foot-pounds of torque is being applied. To take this to the extreme, if the wrench handle is bent so that its centerline is in line with the bolt's centerline, no torque is being applied. The angle at which you hold a wrench makes difference in the torque that you apply to the fastener. Universal joints in a socket wrench extension help reduce the torque that is lost when the torque is applied at an angle to the centerline of the bolt. With a universal joint in a socket wrench extension, the torque may be applied at any angle up to 15 degrees with no significant loss.

075-4.5.1.4 Torque Wrenches. The most dependable and accurate torque wrench is also the simplest and cheapest, the beam type. Either the round or flat beam type will do. To calibrate it, make sure that the pointer is pointing to zero before you start and that it is not rubbing on the scale. A slight bending operation with a pair of pliers will correct either problem. The deflection of its shaft, therefore the reading that you see on the scale, depends on the modulus of elasticity of the material. The modulus does not change with the amount of use or abuse, so the wrench will not get out of calibration unless you somehow manage to reduce the thickness or diameter of the shaft. Various types of torque wrenches, with various size drives and torque ranges, can be found in the Afloat Shopping Guide under Class 5120.

075-4.5.1.5 Tightening Fasteners Using Torque Control. In view of the problems associated with using torque to establish preload that are listed above, you obviously must minimize the effects of those variables. First, if **no other** guidance is available, review the preinstallation inspection procedures in paragraph 075-8.3. Then, follow the steps listed below and you can be reasonably confident that you have established the specified preload.

1. Clean and inspect the threads of the fasteners. If they are not well formed and smooth, get a new fastener.
2. Clean, inspect, and repair the fastener and equipment bearing surfaces, being careful not to nick the bolt head-to-shank, fillet as this is a point of high stress concentration.
3. Clean the mating surfaces of the parts to be joined. Make sure that no metal is pulled up around threaded holes and that there is a slight chamfer at the hole entrance.
4. Apply a good lubricant, or an approved antiseize compound if operating temperatures are above 300°F and there are no instructions prohibiting the use of lubricants (see paragraph 075-4.6.1), to the threads and bearing surfaces. Lubricate both the internal and the external threads so that some of the lubricant will be pushed ahead as the threads engage and provide lubrication for the bearing surfaces.
5. Evenly snug up all the fasteners, making sure that the mating surfaces of the joint do not become cocked in the process.
6. Determine the proper tightening sequence, from the equipment specifications, if available; if not, then from [Figure 075-4-1](#).
7. Then, holding the torque wrench properly, apply the torque slowly and smoothly, tightening the fasteners uniformly, a little at a time. A good practice is to apply about 10 percent of the specified torque first to make sure that the parts are solidly together. Then, apply torque in 25 percent increments (i.e. 25, 50, 75, and 100 percent).

8. Finally, reverse previous sequence (i.e. 6, 5, 4, 3, 2, 1), tightening at 100 percent of required torque.

075-4.5.1.6 Special Requirements for Spiral-Wound Gaskets. Spiral-wound gaskets provide an excellent seal for high-pressure or high-temperature joints, or both, and are available in a variety of shapes. However, special requirements apply to tightening fasteners used with these gaskets. If you follow these special requirements, the result should be a trouble-free joint. These joints have design features that help you get the proper gasket compression. This is done either by using a compression control ring around the outside of the gasket or by providing a recess of the proper depth in the flange for the gasket. The ring around the outside of the gasket also serves to center the gasket. Both the thickness of the ring and the depth of the recess are machined to a specified dimension, usually 1/8 inch. For detailed information concerning the proper installation and bolting-up procedures for spiral-wound gaskets, refer to **NSTM Chapter 078, Volume 2, Gaskets and Packing**.

075-4.5.1.7 Changes in Torque as Fastener Yields. As a fastener begins to yield, there is no drop in torque, nor is there any reduction in preload. On the contrary, the torque continues to increase with further tightening, as does the preload. The rate of increase in torque and preload drops off until there is no further increase. Only after this point will there be a reduction in torque or preload; the fastener is then no longer yielding but failing. The first stages of yielding actually work to harden the fastener and increase its strength. If there is any significant amount of yielding, however, the fastener will suffer fatigue damage and its fatigue life will be reduced. Standard practice in the steel construction industry is to turn the nuts on some fasteners to the point of yield (that is, to the point where the rate of increase in torque with further tightening reduces significantly) and then a little more to ensure that the maximum amount of preload has been applied. This is one positive way to be sure you have reached the specified preload. Don't do this on shipboard applications unless the specific drawings or equipment manuals specify it. The steel construction industry uses special fasteners with high ductility, which allows them to stretch a significant amount without damage; shipboard fasteners may lack such ductility.

075-4.5.2 TURN-OF-NUT CONTROL. Some applications will specify how far to turn a nut instead of torque values. This method, if done properly, produces more predictable preload. You know the pitch of the bolt's thread, so you know how far the bolt will be stretched when you turn the nut one complete turn. Since you know the mechanical properties of the bolts, you can tell how far to stretch the bolt to establish a particular preload. A turn of only a flat or two is usually all that is required.

075-4.5.2.1 The Basis of Turn Requirements. Determining turn requirements is an engineering task beyond the scope of this manual. When this method is to be used for preload, the requirements will be identified on drawings or in technical manuals. The following example is over simplified but provides some understanding how this method of establishing a preload works.

Example: Assume a steel stud bolt (modulus of elasticity equals 30,000,000 psi) with a length of 10 inches between the two nuts and a cross-sectional area on 1.0 square inch and a pitch of 10 threads to the inch. To develop a preload of 30,000 pounds, how much do you have to turn the nut past hand tight?

Calculations:

E = Modulus of Elasticity
= 30,000,000 psi

L = Length (effective)
= 10 inches

A = Cross-sectional area
= 1.0 square inches

T_p = Thread pitch
= 10 threads per inch

P = Desired Preload
= 30,000 pounds

Stress = P/A = 30,000 lbs/1.0 in²
= 30,000 psi

Stretch Required
= Stress * L/E
30,000 lb/in² * 10 inches over
30,000 lb/in²
= 0.010 inches

Stretch/Turn = $1/T_p$
= 1 inch/10
= 0.1 inch/turn

Turns Required
= Stretch Required
over Stretch/turn
= 0.010 inches over 0.1 inch/turn
= 0.1 turn

Degrees Required
= Turns Required
*360 degrees/turn = 0.1 turn
*360 degrees/turn = 36 degrees

A six sided hex nut has 60 degrees to a side, in this case a turn of a little over one-half a side (flat) is required to develop the preload. The actual calculations may consider how much of the stretch occurs in the threads as opposed to the shank of the bolt and also the stretch that occurs in the nut. Compression of the flange and any gasket also need to be considered.

075-4.5.2.2 Units of Measurement. The amount you need to turn the nut is given either in degrees, number of flats or fractions of a flat. With six flats on a hexhead nut and 360 degrees in a circle, one flat is worth 60 degrees, half a flat 30 degrees, and so on.

075-4.5.2.3 Initial Snugging. Before applying the required turns, snug all fasteners initially as discussed below. For all joints except those with spiral-wound gaskets, you will get better results if you tighten, loosen, and then retighten the fasteners during the snugging operation. This sets the joint faces; gasket, and washer, and makes the threads a little more friendly with each other to establish a good starting point from which to measure the turn-of-nut. How much you tighten the fastener during the snugging operation depends on the size of the fastener and how much preload you need. You will usually snug up all the fasteners evenly to 25 percent of the turn-of-nut specified, let the joint set for a few minutes until the initial stress relaxation subsides, loosen all the fasteners, and then retighten them evenly to the turn-of-nut specified.

NOTE

This initial snugging procedure is not recommended for use with spiral wound gaskets as it may let the gasket slip from its initial position and prevent the gasket from sealing properly.

075-4.5.2.4 Where to Make the Measurements. Although it is easy to scribe a mark on the flange at the corner of the nut, that may not be the best place. What you are interested in is how much the nut rotates relative to the bolt or stud. You must be careful to notice any movement of the bolt or stud while you are tightening the nut (see paragraph [075-4.5.2.4.2](#)). Suggested locations for marking fasteners for measurement of turns are listed below.

075-4.5.2.4.1 Capscrews. Where a capscrew is threaded into a blind hole, the flange face is obviously the place to mark. Pick a convenient spot on the head of the capscrew, scribe a mark at this spot, and then scribe a connecting radial line on the flange.

075-4.5.2.4.2 Stud Bolts. When you have a stud bolt you have to scribe a line across both ends of it. Hold a straight edge in line with two opposite corners of the nut, scribe the line across the stud and mark one end of the line. Then, mark the corner adjacent to the marked end of the line (you really do need to mark the adjacent corner, because it's too easy to lose track of where you were). Now, you can tell how much either nut rotates relative to the stud bolt and then sum the two rotations to get the total turn.

075-4.5.2.4.3 Studs. Marking a stud is a little more complicated. Here, you need also to determine whether the stud turns in its hole. Position a straight edge in line with two opposite corners of the nut as you did with the stud bolt, but this time pick the corners so that the straight edge is over a part of the flange that you can also mark. Now, scribe the line across the end of the stud and also scribe a radial line on the flange at one of the two corners. Then mark the corner of the nut adjacent to the scribed line on the flange, and mark the end of the line on the stud adjacent to the marked nut corner. Now, you can tell how much the nut rotates relative to the stud by looking at the position of the marked corner of the nut relative to the line on the stud. You can also tell if the stud has rotated in its hole by checking the position of the line on the stud relative to the line on the flange.

075-4.5.2.5 Turning the Nut. Always use a torque wrench if you have the right size and can get it on the nut. For some applications you may have to use a slugging wrench because the torque is too high for any other wrench. The only thing you lose by not using a torque wrench is being able to use the final torque value as a check. It also helps to be able to observe any change in the rate of increase in torque, which could indicate gasket collapse, the beginning of yielding of the fastener, or some other local problem associated with one fastener.

075-4.5.3 STRETCH CONTROL. In one way, stretch control is an improved variation of turn-of-nut, or you may say that turn-of-nut is a simplified method of stretch control. In either case, stretch control is a more accurate method of establishing a particular amount of preload than turn-of-nut. In this method, the stretch of a fastener is measured by a micrometer or other suitable means.

075-4.5.3.1 Determining Stretch Requirements. This is done the same way as in the turn-of-nut in paragraph [075-4.5.2.1](#) except that you stop after you have found the stretch requirement. As with turn-of-nut, determining the amount of stretch required to produce a particular preload is complicated, but, if this is the specified method for tightening a particular fastener, you will be given the necessary information.

075-4.5.3.2 Measuring the Stretch. Measuring is done in various ways, depending on the fastener shape. If you can reach both ends of the fastener with a micrometer caliper, that is the best way. If you have a stud or a capscrew, it will be modified so that a micrometer may be used. This is usually done on large (1-1/2 to 2 inches or larger) studs or capscrews. An axially drilled hole, with a small rod installed, will be provided in the fastener. You measure the change in length of the fastener relative to the length of the rod as shown in [Figure 075-4-2](#).

075-4.5.4 **ULTRASONIC STRETCH OR STRESS CONTROL.** Ultrasonic equipment is available that can accurately measure the change in length of a fastener. This equipment is in use for some of the more critical fastener applications, but it is not something that you will find in the typical machinist's tool box. It is important that you know it exists and can be used if you need it. Some more advanced ultrasonic equipment is also available that can measure the stress in a fastener directly. This means that the specified preload can be established reliably every time with reasonable accuracy.

075-4.5.5 **HYDRAULIC TENSIONING AND HEATING.** Two final techniques you may run across are hydraulic tensioning and heating. Hydraulic tensioners are mounted over the fastener and stretch the stud by pulling on its end with a hydraulic piston. This stretches the fastener so that when the nut is run down and torqued, the preload is established and the tensioner can be removed. This can be done on more than one fastener at a time simply by hooking several tensioners up to a common manifold. A similar effect can be accomplished by heating the fastener, causing it to extend in length a specific amount and then snugging up the nut while it is hot. Then, when the fastener cools, it will shrink and develop the required preload. This is usually done by inserting a heating coil in a hole drilled through the length of the bolt or stud. Although these techniques are accurate, they cannot always establish as high a preload as you need. The tensioners also require a lot of working room and heating requires modifications to the fastener. You also have to be careful not to overheat the fastener.

075-4.6 **THREAD LUBRICANTS**

075-4.6.1 **GENERAL.** The use of thread lubricants allows the reuse of a bolt and nut combination with minimal changes in torque-versus-load characteristics. [Table 075-4-3](#) lists some of the lubricants most commonly used on threaded fasteners in systems and provides guidance and limitations on their use. However, if drawings, technical manuals, operating instructions, or other technical requirements specify the use of a specific lubricant, that lubricant should be used except when red lead and graphite in mineral oil per MIL-L-24479 is specified. Where drawings, technical manuals, operating instructions or other technical requirements specify use of red lead and graphite in mineral oil per MIL-L-24479, instead use anti-galling compound per CID A-A-59004 unless the document states use of red lead and graphite in mineral oil lubricant per MIL-L-24479 is an approved exception to NAVSEAINST 9210.41. If the drawings, technical manuals, or operating instructions contain requirements in conflict with the general requirements in [Table 075-4-3](#) clarifying guidance shall be obtained from the cognizant technical authority. [Table 075-4-4](#) provides ordering information for the lubricants listed in [Table 075-4-3](#).

075-4.6.2 **THREAD LUBRICANT APPLICATION.** To be effective, the lubricant should be applied to the complete thread area. Apply a light coat over all the external threads, and then fill the first one or two internal threads. The lubricant in the first threads will then be distributed over the remaining internal threads as the fastener is assembled. Apply the lubricant sparingly so you don't fill blind holes with the compound. Use just enough lubricant to coat all of the threads. Also, be sure to coat the bearing surface of the nut or bolt.

CAUTION

In general, lubrication of all fasteners is recommended unless the technical documentation indicates lubricants are not to be used. However, for nuclear propulsion plant applications, if documentation indicates a specific torque requirement but does not identify the use of a lubricant, no lubricant shall be used.

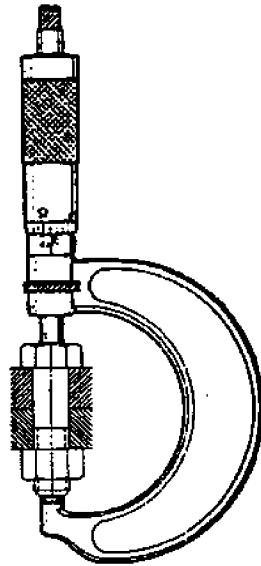

(a) through bolt

pin inserted
into axial
hole of stud

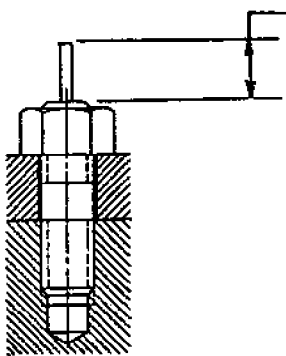

measurement

(b) stud

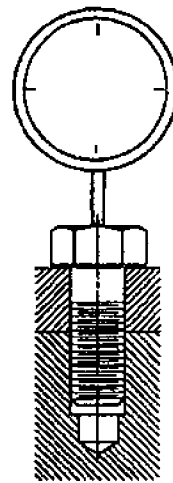

dial
indicator

(c) cap screw

Figure 075-4-2 Measuring the Stretch

CAUTION

For systems and equipment in nuclear propulsion plants, except high pressure air systems, only molybdenum disulfide in isopropanol per MIL-L-24478, anti-galling compound per CID A-A-59004 and graphite in isopropanol per MIL-L-24131 (Military Symbol CGI) are to be used unless otherwise specifically identified on applicable technical documentation. In nuclear propulsion plants, only graphite in isopropanol per MIL-L-24131 (Military Symbol CGI) may be used in applications where the lubricant can potentially contaminate primary coolant.

Table 075-4-3 THREAD LUBRICANTS

Lubricant	Application or Service	Limitations, Prohibitions
CID-A-A-59004 Anti-Galling Compound, Thread Lubricating, Seizing Resistant, and Calcium Hydroxide Containing	Thread lubricant to reduce friction and galling.	Should not be used above 1000°F on low-alloy and carbon steels or above 670°F in all other applications.
MIL-A-907 ¹ Copper Based (FEL-PRO C5-A) or Nickel Based (NEVER-SEEZ PURE NICKEL) Anti-seize compound	High temperature (Up to 1050°F), Steel nuts and bolts of super-heated steam systems. Areas where fastener will be immersed in water or subject to regular wetting or splashing.	Not to be used with stainless steels above 250°F. Not to be used in air systems.
FEL-PRO C5-A (MIL-A-907 ¹) High temperature, Anti-seize compound	Thread lubricant to reduce friction and galling. Class 5 Fits (Driven End Only) Monel and K-Monel	Same as above.
MOLYKOTE M-77 or G	Monel and K-Monel	Not to be used in air systems or fasteners with class 5 fits. See footnote 2.
MIL-S-8660 (Silicon compound) mixed with MIL-M-7866 molybdenum disulfide powder	Lubrication of threads on recompression chambers and systems using air oxygen and other gases	See footnote 2.
DOD-L-24574 Lubricating fluid for low and high pressure oxidizing gas mixtures	Same as above.	Type I -50 to 32°F Type II -4 to 104°F Type III 68 to 158°F
MIL-G-27617 Grease, Aircraft, and Instrument, Fuel & Oxidizer Resistant	Same as above.	Type I -65 to 300°F Type II -40 to 400°F Type III -30 to 400°F Type IV -100 to 400°F
MIL-L-24478 Lubricant, Molybdenum Disulfide in Isopropanol	Thread lubricant to reduce friction and galling in applications having limited clearances and where control of impurities is required.	Not to be used on stainless steels or chrome-nickel alloy 17-4 or at temperatures above 650°F. See footnote 2.
MIL-T-22361 Thread compound, antiseize, zinc dust-petrolatum	For use with components where a fastener is threaded directly into aluminum or its alloys without use of an insert.	Hardens under low temperature conditions and is hard to apply. Not suitable for optical instruments.

Table 075-4-3 THREAD LUBRICANTS - Continued

Lubricant	Application or Service	Limitations, Prohibitions
MIL-L-24131 Lubricant, Colloidal Graphite In Isopropanol	Thread lubricant to reduce friction and galling where lead or sulfur contamination cannot be tolerated.	Not a preferred lubricant where pre-load is established by torque on a nut or screw. See footnote 3 for restrictions.
<p>¹ MIL-A-907, Anti-seize Thread Compound, High Temperature , is being revised. Also, there is no product qualified to the current specification and QPL-907-44 has been canceled. However, thread lubricants manufactured to MIL-A-907, other than those listed above, may be used, on a case by case basis, with the approval of NAVAL SEA SYSTEMS COMMAND, CODE 03M3.</p> <p>² Thread lubricants containing molybdenum disulfide shall not be used in areas where the fastener will be immersed in the water or regularly wetted or splashed with water. Bacteria in the water causes the molybdenum disulfide to breakdown to form compounds (especially sulfur) which attack the fastener.</p> <p>³ MIL-L-24131 should not be used on (1) Nickel-Chrome-Iron alloys (Inconel) above 1200°F, (2) stainless steels, low-alloy, and carbon steels above 1000°F, and (3) Nickel-copper alloys (Monel and K-monel), and chrome nickel alloy 17-4 PH above 670°F.</p>		

Table 075-4-4 THREAD LUBRICANT NATIONAL STOCK NUMBERS

Lubricant	National Stock Number	Size Container
CID-A-A-59004 Anti-Galling Compound, Thread Lubricating, Seizing Resistant, and Calcium Hydroxide Containing	9150-01-446-2164	18 ounce can
FEL-PRO C5-A (P/N 51008)	8030-00-597-5367	2-1/2 pound can
MIL-M-7866 (molybdenum disulfide)	6810-00-816-1025 6810-00-264-6715	Ten ounce bottle One pound can
MIL-S-8660 (silicon compound)	6850-00-880-7616 6850-00-295-7685	Eight ounce tube Ten pound can
MIL-T-22361 (zinc dust and petrolatum)	8030-00-292-1102	Eight ounce tube
MIL-L-24131 (colloidal graphite in isopropanol)	9150-00-926-8963 9150-01-304-6633	Two ounce bottle with applicator Two ounce bottle
MIL-L-24478 (molybdenum disulfide in isopropanol)	9150-00-424-3224 ¹ NSN is for kit requiring mixing of components. The specification now provides for pre-mixed lubricant. For nuclear propulsion plant applications, NSN's for the premixed lubricant have been assigned. (See standard lubricant allowance equipage list in Q-COSAL).	
DOD-L-24574, Type I	9150-01-101-8834	One quart plastic bottle
DOD-L-24574, Type II	9150-01-101-8835	One quart plastic bottle
DOD-L-24574, Type III	9150-01-101-8836	One quart plastic bottle
MIL-G-27617, Type I (grease)	9150-01-007-4384 9150-01-311-9771	Eight ounce tube One pound package
MIL-G-27617, Type II (grease)	9150-01-088-0498	Two ounce tube
MIL-G-27617, Type III (grease)	9150-00-961-8995	Eight ounce tube
MIL-G-27617, Type IV (grease)	9150-01-353-5788	One pound jar
MOLYKOTE M-77 or G (Silicone fluid and molybdenum disulfide powder)	9150-01-112-7052	One pound can
¹ NSN 9155-00-424-3224 is scheduled for elimination. When existing stock is depleted no more will be ordered.		

SECTION 5.

THREADED FASTENER LOCKING

075-5.1 GENERAL

075-5.1.1 **THREADED FASTENER LOOSENING.** Threaded fasteners tend to loosen in service unless certain precautions are taken in the design of the bolted joint and the installation of the fasteners. Loosening is usually caused either by vibration or by mechanical or thermal load cycling. The mechanisms that cause loosening under both these conditions are complex and beyond the scope of this manual. Knowledge of the basic principles involved, however, can help reduce the number of casualties caused by loosening of improperly installed fasteners.

075-5.1.2 **VIBRATION.** Vibration is the most frequent cause of fastener loosening. A screw thread, of course, is nothing more than a wedge or inclined plane wrapped around the shank of a bolt. Just as a wedge can be loosened by shaking or vibrating it from side to side, a nut and bolt will move relative to each other and loosen if the vibration is severe enough, or the joint design or assembly weak enough, for the parts to move.

075-5.1.3 **LOAD CYCLING.** Loosening of threaded fasteners due to load cycling is similar to loosening due to vibration except that the mechanism that causes the relative motion is different. In addition to the slope of the thread as it spirals around the bolt shank, there is a slope to the thread in the radial or outward direction. As a nut is tightened on a bolt, the taper of both threads tends to expand the nut. Both the threads tend to bend slightly. If, after a nut is tightened, the loads on the joint change enough to cause the forces that act on the bolt to change significantly, the nut will expand and contract radially with the cycling of the load. In addition, both threads will bend up and down. These movements are very small, but they are enough to cause relative sliding between the nut, bolt, and bearing surfaces. Just as with vibration, this will cause the fastener to loosen as the wedge of the threads moves back and forth.

075-5.1.4 Remember that, in general, the first objective of locking a fastener is to preserve the fastener preload. Sometimes, however, preload is not required, and sometimes, as in the pivot joints of pipe hanger legs, it is prohibited. In these cases preventing the loss of the fastener and subsequent disassembly of the joint becomes the objective. In all of these cases simply locking a nut onto a stud is not enough by itself; the stud must also be locked into its tapped hole. Likewise, in a nut and bolt assembly, locking the nut to its bearing surface is not enough; the bolt must also be prevented from rotating relative to the nut.

075-5.1.5 Four basic techniques are used to prevent threaded fasteners from loosening in service: preload, prevailing torque, mechanical, and chemical. The proper method for each application will be as specified on applicable technical documentation (drawing, technical manuals, etc.).

075-5.2 PRELOAD METHOD

075-5.2.1 The first line of defense against the loosening of threaded fasteners in service is to tighten them properly at installation. This may sound overly simplistic, but it is probably the least understood and least often satisfied requirement in fastener installation. Properly preloading a fastener all but eliminates the tendency of all the fastener components, studs, nuts, and bolts, to rotate relative to each other

075-5.2.2 Many otherwise competent mechanics seem to consider it degrading to resort to the use of a torque wrench to tighten a nut. This feeling is unjustified, because taking the time to apply the proper torque is a mark of an experienced craftsman. Extensive studies have shown that the only size nuts the average mechanic will properly tighten by feel are 1/2 and 5/8 inch. Smaller ones will be overtightened, many partially yielded, and larger ones undertightened.

075-5.2.3 With the exception of some unusual situations, a fastener that is tightened so that its clamping force (preload) is greater than any load that it meets in service will not loosen in service. [Section 4](#) discusses preload and proper tightening in detail, and gives recommended torque values for applications where equipment manufacturer's data are unavailable.

075-5.3 PREVAILING TORQUE (SELF-LOCKING NUT) METHOD

075-5.3.1 GENERAL. For those unusual situations mentioned above, or where high clamping forces are not desired, such as for linkages using clevises or pipe hanger clamps, prevailing torque devices work well. These are commonly referred to as self-locking nuts. There are as many different types as there are manufacturers. However, the various types can be grouped into two categories: those that generate pressure between the threads of the nut and bolt in a way that permits frequent removal, and those that cause some thread deformation and therefore should only be used where frequent removal is unnecessary. Always keep in mind that simply using a self-locking nut on a stud does little good if the stud itself is not also locked into its threaded hole.

075-5.3.2 REUSABLE SELF-LOCKING FASTENERS. Several groups of self-locking fasteners are considered reusable. These consist of the family of plastic ring and plastic insert nuts and bolts, and spring beam nuts.

075-5.3.2.1 Plastic Ring and Insert Fasteners. The most widely used self-locking fasteners belong to the family of plastic ring nuts and plastic insert nuts and bolts.

075-5.3.2.1.1 Plastic Ring and Insert Temperature Limits. Two types of plastic are in common use in these fasteners, polyamide and polyimide. Polyamide (nylon) can be used at sustained temperatures up to 250°F, polyimide (vespel) is good up to 450°F. It is difficult to determine which one of these plastic materials you have just by looking at them. The nylon inserts tend to be a light color, white or light green bordering on translucent, while the vespel tends toward red, brown, or even black. The high temperature Vespel (polyimide) is also much harder than the lower temperature Nylon (polyamide). If you can determine the manufacturer, then you can usually contact the manufacturer and identify the insert by its color.

075-5.3.2.1.2 Reusing Plastic Ring and Insert Fasteners. Before reusing either the plastic ring or the insert fasteners, check the condition of the plastic and the breakaway torque of the assembly. If the plastic is worn or torn, discard the fastener. If the plastic is in good condition, lubricate the threads and assemble the fastener until the locking element is fully engaged. Check the breakaway torque required to start removal rotation of the fastener with no axial load on it. New self-locking nuts manufactured to MIL-N-25027 should comply with the minimum breakaway torque values listed in [Table 5-1](#). If the breakaway torque is less than that specified in [Table 5-1](#) and no other guidance is available, discard the fastener and use a new one. These fasteners are usually good for approximately 15 reinstallations.

075-5.3.2.1.3 Plastic Ring Nuts. One of the more common self-locking devices is the family of plastic ring nuts ([Figure 075-5-1](#)), which deform their plastic inserts when they are installed. These are usually referred to as elastic stop nuts. At installation the resilient plastic material is forced to assume the shape of the mating threads,

creating large frictional forces that resist rotation of the nut on the bolt. The part standards listed in [Figure 075-5-1](#) for plastic ring nuts frequently used aboard ship are listed in MIL-N-25027, **Nut, Self-Locking, 250°F, 450°F, and 800°F**. Self-locking nuts whose breakaway torque is less than that shown in [Table 075-5-1](#) shall not be reused.

NOTE

Elastic stop nut may require a longer bolt than do standard nuts; the elastic stop nut is thicker because of the addition of a plastic locking ring, and as a minimum the male thread shall protrude or at least be flush with locking element.

075-5.3.2.1.4 Plastic Insert Bolts and Nuts. A variation on the plastic ring nut is the plastic plug or pill. A hole or groove is machined in the side of the bolt or nut. Plastic plugs, which do not extend completely around the circumference of the fastener, are then inserted into the machined openings. As with the plastic ring nuts, these inserts deform at installation, forcing the nut to one side, thereby creating the antirotation friction force. Once the fastener is tightened, however, it tends to center itself. This centering causes some motion between the nut and bolt, especially if the fastener is not completely preloaded, making this type less effective than the plastic ring nuts. This type of fastener and its specifications are described in MIL-F-18240, **Fastener Element, Self-Locking, Threaded Fastener, 250°F Maximum**. See [Figure - 075-5-2](#). Self-locking fasteners with a breakaway torque less than that in [Table 075-5-1](#) shall be replaced.

Table 075-5-1 PLASTIC RING AND INSERT FASTENER BREAKAWAY TORQUE

Nominal Thread Size, inch	Minimum Breakaway Torque, in-lb
#2 (0.068)	*
#4 (0.112)	*
#5 (0.125)	*
#6 (0.138)	*
#8 (0.164)	*
#10 (0.190)	1.0
#12 (0.216)	1.0
1/4	1.5
5/16	2.5
3/8	4.0
7/16	5.0
1/2	7.5
9/16	10.0
5/8	12.5
3/4	20.0
7/8	30.0
1	40.0
1-1/8	50.0
1-1/4	60.0
1-3/8	70.0
1-1/2	90.0
1-3/4	100.0
2	120.0
2-1/4	140.0

Table 075-5-1 PLASTIC RING AND INSERT FASTENER BREAKAWAY

TORQUE - Continued

Nominal Thread Size, inch	Minimum Breakaway Torque, in-lb
2-1/2	165.0
*Must have some indication of torque increase as locking feature comes in contact with bolt.	

075-5.3.2.2 Reusable Metal (Spring Beam) Self-Locking Nuts. Spring beam (spring finger) nuts come in various shapes, although all are similar to that shown in [Figure 075-5-3](#). This type of nut has thin slots cut down through the top few threads with the resulting fingers effectively bent inward. They appear similar to castellated nuts except that the cuts are much narrower. At installation, the bolt springs the fingers out, with the resulting spring action causing fingers to grip the bolt with a prevailing torque, even when the nut and bolt assembly is loose in its hole (not exerting any clamping force). The following part standards for reusable metal self-locking nuts are listed in MIL-N-25027:

MS21046	Nut, Self-Locking, Hexagon-Regular Height, 450°F, 125 KSI Ft _u
MS21046	Nut, Self-Locking, Hexagon-Regular Height, 800°F, 125 KSI Ft _u

075-5.3.2.2.1 Metal Self-Locking Nut Temperature Limits. Corrosion-resistant steel self-locking nuts are available for applications up to 800°F (MIL-N-25027)

Standard	Title - Material
MS16228	Nut, Self Locking, Hexagon, Thin, UNC 3B (Nonmetallic Insert) Austenitic, Corrosion Resistant Steel, Nonmagnetic, 250°F
MS17828	Nut, Self Locking, Hexagon, Hexagon, Regular Height, Nonmetallic Insert, 250°F, Nickel Copper Alloy
MS17829	Nut, Self-Locking, Hexagon, Regular Height, Nonmetallic Insert, 250°F, Noncorrosion-Resistant Steel
MS17830	Nut, Self-Locking, Hexagon, Regular Height, Nonmetallic Insert, 250°F, 300 Series Corrosion-Resistant Steel
MS21044	Nut, Self-Locking, Hexagon, Regular Height, 250°F, 125ksi Ft _u and 60 ksi Ft _u (Aluminum, Steel, Brass & CRES)
MS21083	Nut, Self-Locking, Hexagon, Nonmetallic Insert, Low Height, 250°F (Aluminum, Steel, Brass & CRES)
MIL-N-25027/1	Nut, Self-Locking, Heavy Hex, (Non-Metallic Insert) 250°F and 450°F, UNJC-3B, 1/4 Through 2-1/12 Inch Nominal Diameters, Nickel-Copper Alloy

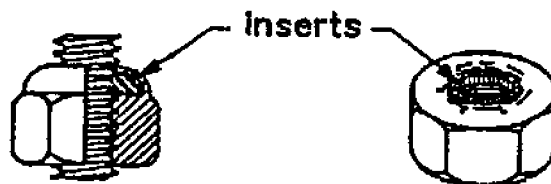

075-5-1 Plastic Ring Nut

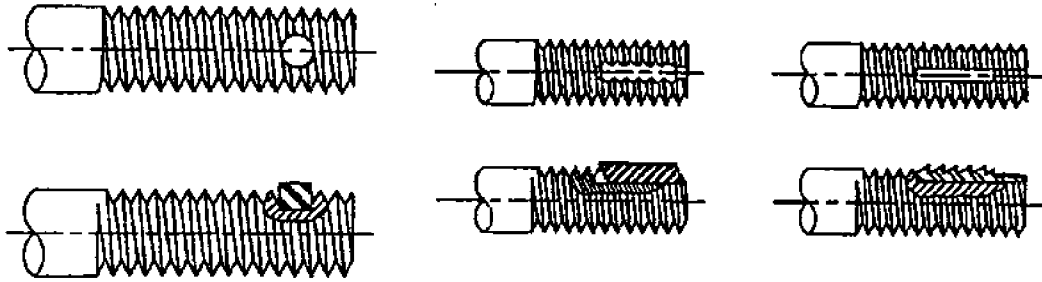

075-5-2 Types of Self-Locking Bolts

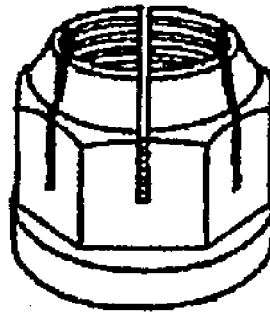

075-5-3 Spring Beam Nut

075-5.3.2.2.1 Reusing Metal Self Locking Fasteners. Reusable metal self-locking fasteners work well when first installed and can usually be reused 15 times. When they are repeatedly removed and reinstalled, however, they tend to lose their grip and eventually become ineffective. Check the amount of breakaway torque required to start rotation of the nut, using a torque wrench. Check this value against the specified torque (or compare it with the data in [Table 5-1](#) if no other guidance is available). If the breakaway torque is below allowable torque limits, replace the nut.

WARNING

Do not use these nuts on studs unless the studs can be easily replaced.

075-5.3.3 NONREUSABLE SELF-LOCKING FASTENERS. Non-reusable self-locking fasteners are usually of the metal distorted thread or distorted collar type. In this fastener, some of the threads or the collar are distorted. At installation, the distortions are bent back into alignment. Most of this bending is elastic, like a spring, and the spring force keeps the threads tight. Some of the bending results in permanent deformation, however, of either or both the nut and the bolt threads. As a result, the number of times these nuts can be reused, if any, is limited. Since parts of the fastener are being deformed, if either high or low prevailing torque is experienced, replace the nut or the bolt or both. Carefully clean the threads on both the nut and the bolt and lubricate them before assembly, as some metals tend to gall when used with this type of nut (refer to [Table 075-4-3](#)).

075-5.3.3.1 Distorted Collar Nuts. Distorted collar nuts ([Figure 075-5-4](#)) either have an oval steel collar insert or a collar formed with a rounded triangular opening. As the nut is threaded on, the bolt forces the nut or collar

back into round. The spring properties of the nut cause it to try to return to its distorted shape, creating high frictional forces between the nut and the bolt. These nuts are not commonly used on board ship. However, they may be found in high temperature components where plastic locking elements cannot be used or in specialized components as part of a positioning device.

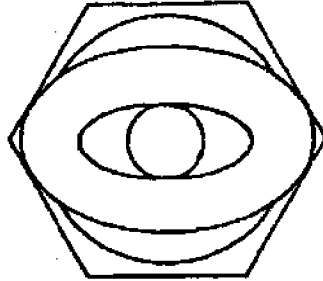

075-5-4 Distorted Collar Nuts

075-5.3.3.2 Distorted Thread Nuts. Distorted thread nuts are made either with depressions on the face of the nut, which distort a few of the top threads locally, or depressions in the center of three of the wrench flats, which distort some of the threads in the center of the nut. In both designs, threading the nut on the bolt forces the threads back into round. As in the distorted collar nuts, the spring properties of the nut cause it to try to return to its distorted shape, creating high frictional forces between the nut and the bolt. Similar to the distorted collar nuts above, these nuts are not commonly found on board ship. They may also be found in high temperature components where plastic locking elements cannot be used or in specialized components as part of a positioning device.

075-5.3.4 JAM NUTS (LOCK NUTS). Jam nuts are an older variation of the prevailing torque concept. They are not usually recommended for new installations due to the tendency to use an improper thickness for the jam nut and to install them in the wrong relative positions.

075-5.3.4.1 Jam Nut Assembly. The jam nut assembly requires a regular or main nut and a thin jam nut, as shown in [Figure 075-5-5](#). The assembly is installed with the thinner nut between the thick nut and the bearing surface. The main nut has to be as thick as if no jam nut were being used, because the main nut carries all the working load. The jam nut is usually about 2/3 as thick as the main nut. If the jam nut is too thin, however, the threads in the jam nut area will be damaged as the main nut will pull the bolt threads partially through the jam nut. Conversely, if the jam nut is too thick, the main nut cannot distort the threads enough.

075-5.3.4.2 Tightening the Jam Nut. At assembly, first tighten the jam nut to the same or slightly less percentage of the preload torque specified for the main nut, based on the relation the jam nut thickness bears to the thickness of the main nut. Then hold it in position with a wrench while you tighten the main nut. For example, if the jam nut is 2/3 as thick as the nut, tighten the jam nut to 1/2 to 2/3 of the torque used for the main nut. Then, when the main nut is tightened to the preload torque specified for the bolt, it stretches the bolt (stud), thereby tending to pull it through the jam nut. Any vibration or load that tends to loosen the bolted joint will allow the bolt to shrink back to its original length, leaving the jam nut tight against the main nut. This creates the necessary prevailing torque to prevent the jam or main nut assembly from rotating on the bolt.

075-5.3.5 SETSCREWS. Setscrews are seldom used in the U.S. Navy. Setscrews can be used in a variety of ways to lock threads (see [Figure 075-5-6](#)). A setscrew can:

- a. Jam a plug of softer material (plastic, copper, or lead) against the threads to be locked.

- b. Be installed between the nut and a stationary member, physically restricting the nut from turning.
- c. Be installed in a threaded hole drilled axially at the junction of the mating threads, physically restricting the nut from turning on the bolt.

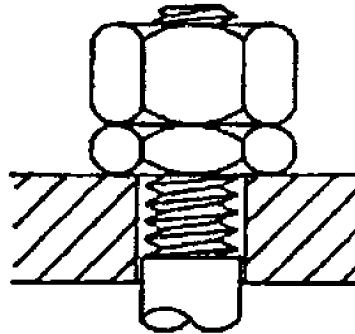

075-5-5 Jam Nut Assembly

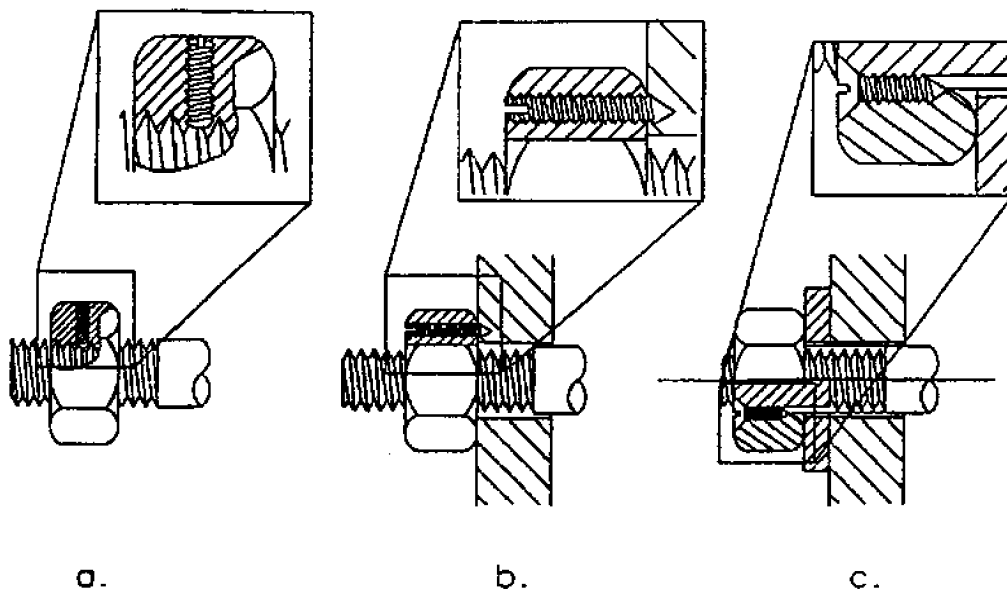

075-5-6 Setscrews

NOTE

Methods b and c are not recommended for applications where the fastener is highly loaded, as the nut is significantly weakened by the extra hole. The use of setscrews also tends to create another problem, because now you have to find a way to lock the setscrew.

075-5.4 MECHANICAL METHOD

075-5.4.1 GENERAL. Mechanical locking devices come in a wide variety of designs, but they fall into one of three basic types: pins, wires, or tabs. Generally, these devices work well where the objective is to prevent total

disassembly of the joint. Where the objective is to maintain a specified fastener preload, however, they have their drawbacks. Cotter pins and lock wires do limit rotation of the fastener to 2 or 3 degrees; however, it only takes 2 degrees of rotation for a hard joint to lose 25 percent of the preload, and 6 degrees to lose 40 percent of the preload. A second problem with cotter pins and lockwire is that they are not very strong, especially lock wire. It takes only a few foot-pounds of torque to shear a lock wire and only slightly more for cotter pins. Driven pins and tabs also have their problems, which are discussed in the applicable sections. The information below describes the various mechanical methods for locking fasteners that you may encounter aboard ship. Use these methods only where specified on equipment drawings or in equipment technical manuals.

075-5.4.2 PINS. Various types of pins have been designed to prevent nuts from rotating on bolts. They are used in one of three ways: (1) with castellated nuts, (2) in holes drilled through the body of the nut (using an extra tall nut and drilling the hole in the center of a wrench flat) and through the bolt, and (3) through the bolt at a point beyond the nut.

075-5.4.2.1 Cotter Pins. Cotter pins (cotter keys) are used with castellated nuts and installed as shown in [Figure 075-5-7](#). Cotter pins may be found in the Afloat Shopping Guide under Federal Supply Class 5315.

CAUTION

When cutting off excess lengths of cotter pins, be careful to keep the cut end from getting into open machinery or flying out and injuring personnel. Hold the end with a suitable plier while it is being cut or, if you are careful not to let the cut end fall out of the rag, hold a rag over the end while you are cutting it.

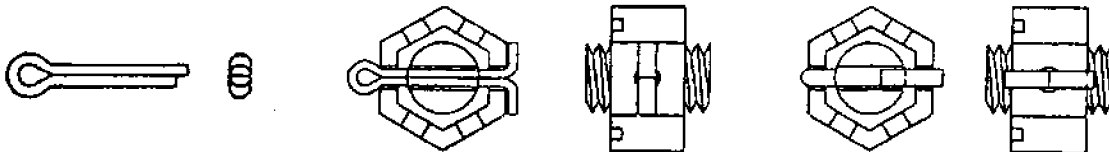

075-5-7 Cotter Pin

075-5.4.2.1.1 Installing Cotter Pins. Cotter pins are usually installed with the long end of the pin on the side toward the end of the bolt and the head of the cotter pin resting in the slot in a castellated nut. The long end of the pin is bent up and back over the end of the bolt. The remaining end is then cut to a suitable length and bent down over the flat of the nut. Where an interference or safety problem exists, the cotter pin can be rotated 90 degrees with its head outside of the slot in the nut and the ends bent back around the sides of the nut. An additional option is to install the cotter pin with its head in a slot, grip the ends of the pin with a plier, twist the end 90 degrees so that the twist is distributed over the length of the pin, and then bend the ends back around the nut.

075-5.4.2.1.2 Installation Problems. Two primary difficulties are associated with using cotter pins and castellated nuts. First, it is often difficult to torque the nut properly and get the holes to line up at the same time. This often requires trying several different nuts until one fits. Second, when using a new, undrilled bolt, it is difficult to drill a hole in the bolt with the fastener installed, especially with high-strength bolts that are hardened. The hole must be centered and drilled at right angles to the bolt centerline. Also, the drill chips must be kept out of any open sections of machinery. It is also very difficult to properly mark the hole's location with the fastener properly torqued and then remove the bolt and take it to a shop for drilling. Nevertheless, if the hole cannot be drilled properly with portable drills, or if the drill chips could fall into open machinery, the fastener must be removed for drilling. It is also good practice to break the sharp edges at the ends of the hole in the bolt after drilling.

075-5.4.2.2 Driven Pins. The next two threaded fastener locking methods are rarely used but you may encounter them. These methods consist of driving different types of pins through holes drilled through the fastener. Several different types of drive pins are used. The more common ones being taper pins, grooved taper pins, straight pins, roll-pins, and spiral-pins. These are shown in [Figure 075-5-8](#). Drive pins may be found in the Afloat Shopping Guide under Federal Supply Class 5315.

075-5.4.2.2.1 Drive Pin Through Nut and Bolt. This locking method drives a pin through a hole that has been drilled through the nut and bolt. The same problems exist here as with cotter pins, only more so. Here, the hole has to be drilled with the nut and bolt assembled and properly torqued. Once the joint has been disassembled and then reassembled and properly retorqued, the holes will probably not line up, even if the same nut is back on the same bolt. The only place this process will work is where the nuts need not be tightened significantly or torqued to a specified value, such as in linkage clevises. Other locking methods should be considered first, however.

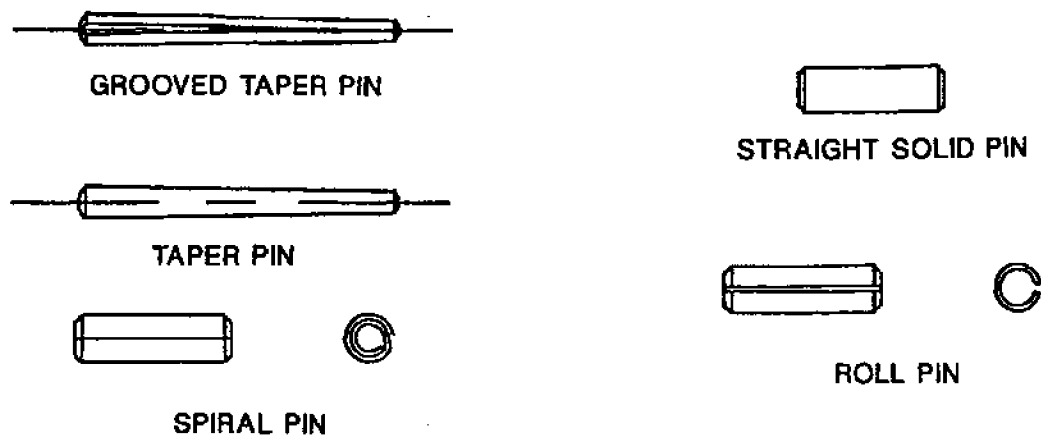

075-5-8 Types of Drive Pins

075-5.4.2.2.2 Drive Pin Through Bolt Only. This locking method drives the pin through a hole drilled through the bolt beyond the nut. This method is used where a few rotations of the nut can be tolerated but complete loosening of the joint is to be prevented.

075-5.4.2.3 Use of Hardened Drive Pins. Wherever possible use a roll-pin or a spiral-pin. These are hardened pins and will resist shearing better than nonhardened taper or straight pins.

CAUTION

Never drive a pin into, bend a tab onto, use staking, peen, or otherwise hammer on any fastener assembly that is supported by a ball, roller, needle, or other rolling element bearing. You wouldn't beat on a ball bearing with a hammer would you? Hammering on a shaft that is supported by ball bearings is the same thing, or maybe worse. The performance of a specially designed quiet ball bearing can easily be ruined and any rolling element bearing damaged by impact forces. If this situation exists, use a self-locking fastener or chemical method that is appropriate for the temperatures involved.

075-5.4.2.3.1 Installing Roll Pins and Spiral Pins. Roll pin and spiral pins are driven into straight holes. The pins are slightly larger than a standard drill for the stated size. The pins have a short taper on each end to help start them into the hole. As the pins are driven in, they compress and remain tight until driven out.

075-5.4.2.4 Installing Straight Pins. Straight pins should be driven into interference fit holes; however, it is acceptable to drive them into size-on-size holes (i.e., holes with the same diameter as the pin). In the latter case, either leave the pin too long and peen it over on each end or make it too short and stake it in place at each end.

075-5.4.2.5 Installing Taper Pins. Taper pins must be driven into tapered holes that have been reamed with the proper taper reamer. The taper is the American standard taper of 1/4 inch per foot. The pins are numbered from 0 to 10 to designate their size. The number 0 pin has a large-end diameter of 0.156 inch, the number 10 pin has 0.706 inch. Properly sized and tapered reamers are available with numbers the same as the pin they are to be used with. Drive the taper pin in until it is tight but not so tight as to distort it. The taper is slight enough to wedge the pin firmly in place and prevent it from loosening in service and yet permit it to be driven out when required.

075-5.4.2.6 Aligning Holes for Pins. Where fastener preload torque requirements are specified, they must be met. If you cannot align the locking pinholes within those limits, try other nuts or replace and redrill the entire fastener. Note that only one hole is permitted in a stud or a bolt.

075-5.4.2.7 Substitutions for Pin-Type Locking Devices. Where service has been satisfactory, continue to use the pins. If loosening in service or difficulty in achieving proper preload torque has been a problem, however, replace them with self-locking fasteners. If a self-locking fastener is installed where another fastener is called for, submit a waiver request to document this configuration change.

075-5.4.3 TAB LOCKS. Tab locks ([Figure 075-5-9](#)) have a tab bent against one or more of the wrench flats of the nut or bolt to prevent the nut or bolt from turning. You can keep the tab lock itself from turning in a number of ways: You can bend a second tab against a nearby flange or over a nearby edge. Where the equipment permits, you can drill a hole into the adjacent surface and bend a tab into the hole. Where the configuration permits, a tab lock can be made to fit under two adjacent bolts or nuts. You can also use a screw to lock the tab to the adjacent surface, but the screw now has to be locked by some means such as anaerobic thread-locking compound. Special tab locks that lock by means of an internal key slot or flat surface are sometimes used on studs or shafts with key slots or flat sections cut to accept them.

075-5.4.3.1 Installing Tab Locks. Tighten the fastener to the minimum specified torque limit. Stop tightening at this point and check to see if a flat face is presented to the tab. If not, continue to tighten until alignment is reached but not more than the maximum specified torque. Do not bend the tab until you have completed all required retorquing. Never try to bend a tab against a corner. If you cannot make the flat side face the tab, use another nut or bolt. Always torque with clean, lubricated threads and a clean, lubricated nut or bolt face (bearing surface). See paragraph 075-4.6.1 for further guidance concerning lubrication.

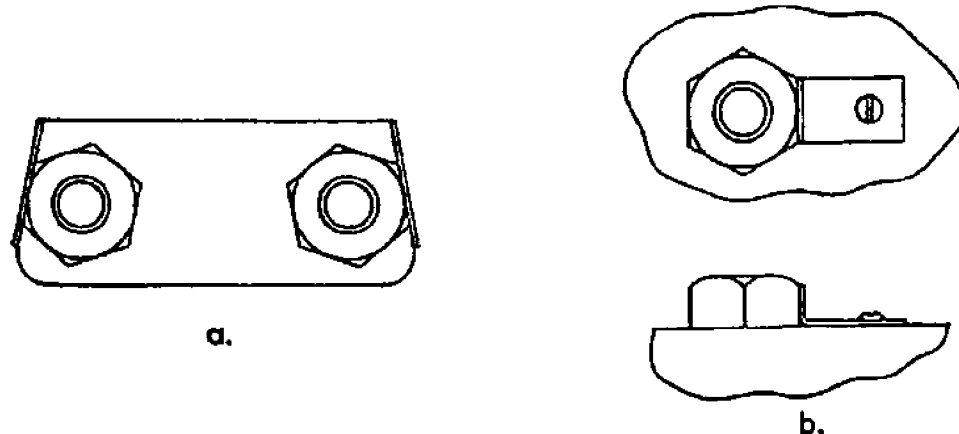

075-5-9 Tab Locks

075-5.4.3.2 Tab Bend Radius. Whenever a tab is bent, the outside of the bend radius areas should be inspected for cracks, especially for aluminum tabs. Tabs are not designed for re-bending; therefore, unless multiple tabs are provided or the tab lock is pre-bent and screwed into place, the tab lock should not be reused.

075-5.4.4 STAKING AND PEENING. Avoid staking, peening, center punching, and similar methods of locking threads that distort the threads after assembly. Although these methods may be replaced in kind if loosening has not been a problem, they should always be replaced with self-locking fasteners whenever disassembly is required. This does not apply to straight pins that have been staked or peened in place. If staking or peening is to be used, the screw, stud, or bolt should be staked or peened at two points around the circumference. This allows at least two subsequent removals or reinstallations.

075-5.4.4.1 Staking. Staking usually involves moving material, usually with a center punch, from an adjacent surface against the head of a recessed screw or bolt, or deforming external threads beyond the nut. It also includes various other forms of distorting either the fastener or the adjacent material with punches or chisels in an attempt to lock a fastener.

075-5.4.4.2 Peening. Peening is similar to staking except it usually involves forging (peening) the end of a pin or bolt to expand it. In the case of a bolt or stud, it prevents the nut from coming off. However, it may permit some rotation of the nut. In the case of a pin, the ends of the pin are simply expanded so that the pin cannot back out of the hole.

075-5.5 SAFETY WIRE METHOD

075-5.5.1 GENERAL. The primary purpose of safety wiring is to prevent complete loss of a fastener. It's not particularly effective in preventing minor relative nut and bolt rotation and subsequent loss of preload. Safety wire is installed by passing single strand, relatively ductile, wire through the drilled holes of adjacent bolt or cap-

screw heads, or, in the case of studs, through the slots of castellated nuts and the aligned holes in the ends of studs. Many components such as diesel engines, compressors, and gas turbines, still have safety wired fasteners, especially in internal locations. It's effective in preventing complete loss of the fastener. It is, however, an ineffective method for preventing loss of preload; some rotation can still occur, even with the best of tying techniques. Rotation of only a few degrees can reduce the preload by 50 percent. In addition, because it must be bent and twisted, ductile wire is usually used. Ductile wire, however, is weak and stretches easily, allowing significant fastener rotation. Safety wire may be used to replace previous existing safety wire. If loose or broken wires or loose fasteners are found at disassembly, however, self-locking fasteners may be installed at reassembly. If a self-locking fastener is installed where safety wire is called for, submit a waiver request to document this configuration change. If no other guidance is provided, install safety wire in accordance with MS33540, **General Practices for Safety Wiring and Cotter Pinning**. Use only safety wire that complies with MS20995, **Safety or Lock Wire**.

075-5.5.2 REWIRING. When rewiring, always use the type of wire specified for the application. Do not use wire that was previously used, except under emergency conditions. Replace used wire as soon as the proper wire is available.

075-5.5.3 TIGHTENING SAFETY WIRED FASTENERS. All torquing operations must be completed before you install the safety wire. Do not loosen or overtorque the fastener to achieve a better wire alignment.

075-5.5.4 WIRE INSTALLATION. [Figure 075-5-10](#) shows acceptable safety wiring techniques. Additional guidance is provided in MS33540, **General Practices for Safety Wiring and Cotter Pinning**. Cut the excess wire and bend the end toward the nut or part. Projecting ends are a safety hazard.

075-5.6 LOCKWASHER METHOD

075-5.6.1 GENERAL. Many installations aboard ships, especially older ships, still use lockwashers in diesel engines and similar equipment to prevent threaded fasteners from loosening. These may be replaced with the same type of fastener if loosening has not been a problem. If loosening has been a problem, however, replace the lockwashers with self-locking fasteners. Standard lockwashers are detailed in ASME B18.21.1 (inch) and ASME B18.21.2M (metric). Lockwashers in common use consist of the helical spring, curved or conical spring, internal tooth, external tooth, and internal-external tooth type.

075-5.6.2 HELICAL SPRING LOCKWASHERS. The most frequently used lockwasher is the helical spring (split) type. The helical spring lockwasher ([Figure 075-5-11](#)) is flattened when the bolt is torqued down. Once compressed, it acts as a flat washer, contributing normal friction between the nut or bolt and the bearing surface during tightening. If the fastener clamping load relaxes, the spring action of the lockwasher will maintain some load between the threads of the fastener, reducing the tendency of the fastener to rotate. Some helical spring lockwashers have a sharp tooth on each end that bites into each bearing surface and prevents rotation. This type adds friction during tightening and will result in some reduction in preload. Because the helical spring lockwasher diameter is small and it tends to dig in when loosened, it is rarely used on soft materials or with oversized or elongated holes.

075-5.6.3 CURVED OR CONICAL SPRING LOCKWASHERS. Curved or conical (Belleville spring) lockwashers ([Figure 075-5-12](#)) have properties similar to the helical spring lockwasher. Unlike the helical spring lockwasher, however, they provide a relatively constant tension on the fastener over a significant range of deflection when the clamping load is reduced. They are also usually larger in diameter, which helps to distribute the

clamping load better. Unless the washer is very thick, as thick or thicker than a heavy helical spring lockwasher, the tension produced is usually less than that produced by the helical spring lockwasher and therefore less effective. Some high load applications requiring high-strength fasteners use a large, thick, hardened version. Because the belleville spring washer has constant force characteristics, it is sometimes used to compensate for thermal expansion of some components while still maintaining the proper fastener preload. Where these types of washers are found, they shall continue to be used and replaced in kind.

075-5.6.4 TOOTHED LOCKWASHERS. Toothed lockwashers ([Figure 075-5-13](#)) are washers with twisted or bent teeth around the outside, inside, or outside and inside. As the fastener is tightened, the teeth flatten, providing a somewhat uniform bearing surface. When the fastener loses its clamping load and tries to rotate the teeth bite into both bearing surfaces and resist rotation as long as the deflection range of the teeth is not exceeded. Tooth-type lockwashers are preferred for use in electrical applications since the teeth maintain a larger area of contact.

075-5.6.4.1 Internal Tooth Lockwashers. The light internal tooth type lockwashers are used under small-headed screws; the heavy internal-type lockwashers are used with large nuts and bolts.

075-5.6.4.2 External Tooth Lockwashers. Where engagement of all the teeth by the bearing surfaces of both the fastener and the component can be ensured, the external tooth types provide better service than the internal types.



EXAMPLE 1

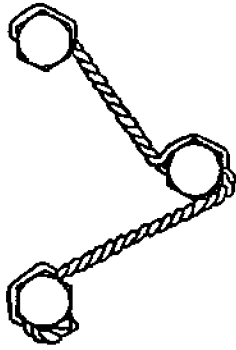

EXAMPLE 2

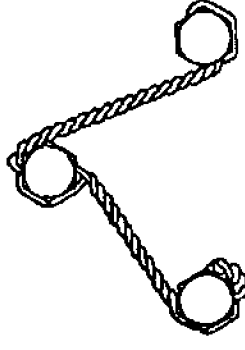

EXAMPLE 3



EXAMPLE 4



EXAMPLE 5



EXAMPLE 6



EXAMPLE 7

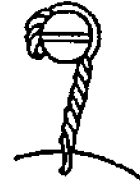

EXAMPLE 8

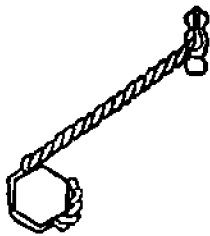

EXAMPLE 9



EXAMPLE 10



EXAMPLE 11

075-5-10 Safety Wiring Examples

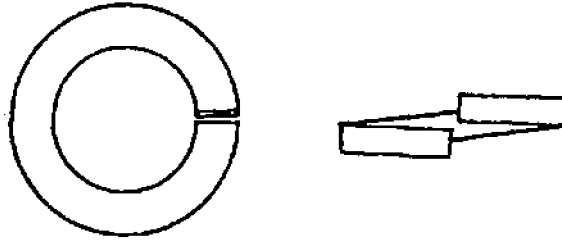

075-5-11 Helical Spring Lockwasher

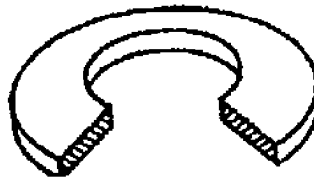

075-5-12 Curved or Conical Lockwasher

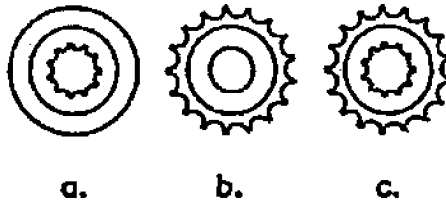

075-5-13 Toothed Lockwashers

075-5.6.4.3 Internal-External Tooth Lockwashers. For oversize holes or where a large bearing surface is required, the internal-external type lockwasher is recommended. The internal-external type is sometimes used as an insert between members that have oversize or elongated holes and require position adjustment before the fastener is tightened.

075-5.6.5 PART NUMBERS. As previously mentioned (paragraph 075-2.5.1), standard part numbers for lockwashers are identified in MIL-STD-1764, **Washers, Preferred for Design, Listing of** . Some of the lockwasher standards, covered in MIL-STD-1764, are listed in [Table 075-5-2](#).

075-5.7 CHEMICAL METHOD

075-5.7.1 GENERAL. A number of chemical threadlocking compounds are available. Those approved for naval use are the anaerobic compounds that comply with MIL-S-22473, **Sealing, Locking, and Retaining Compounds; Single-Component**, and MIL-S-46163, **Sealing, Lubricating and Wicking Compounds: Thread-Locking, Anaerobic, Single-Component**. [Table 075-5-3](#) lists some of the NSNs that may be used for procuring these anaerobic compounds. For systems and equipment in nuclear propulsion plants, only Grade AV and AVV per MIL-S-22473 are to be used unless otherwise specifically identified on applicable technical documentation. The appropriate **General Reactor Plant Overhaul and Repair Specification** Section 9090-3 provides restrictions on the use of locking compounds in the reactor plant.

075-5.7.2 ANAEROBIC THREADLOCKING COMPOUND. Anaerobic threadlocking compounds usually have methacrylate ester as a base. These compounds cure (polymerize or harden) in the absence of air hence the term anaerobic. The hardened compound then resists rotation of the parts because it has both bonded to the threads as an adhesive and penetrated the pores of the thread material to provide a mechanical lock.

Table 075-5-2 LOCKWASHER STANDARDS

Military Standards	Fasteners Sizes (nominal)	Materials
MS35333, Washer, Lock, Flat-Internal Tooth	#2 (0.086 inch) through 1.000 inch	Carbon Steel CRES Phosphor Bronze Tin-Bronze
MS35334, Washer, Lock-Flat, Heavy, Internal Tooth	0.250 (1/4 inch) through 0.875 (7/8 inch)	Carbon Steel
MS35335, Washer, Lock, Flat-External Tooth	#4 (0.112 inch) through 1.000 inch	Carbon Steel CRES Phosphor Bronze Tin-Bronze
MS35338, Washer, Lock-Spring, Helical, Regular (Medium) Series	#2 (0.086 inch) through 1.500 inch	Carbon Steel CRES Phosphor Bronze Tin-Bronze Nickel-Copper-Aluminum
MS35340, Washer, Lock-Helical Spring, Extra Duty (Extra Heavy) Series	#2 (0.086 inch) through 1.500 inch	Carbon Steel
MS35790, Washer, Lock-Countersunk, 100°F, External Tooth	#2 (0.086 inch) through 3/8 (0.375 inch)	Carbon Steel Phosphor Bronze Tin-Bronze
MS45904, Washer, Lock, Internal and External Tooth	#4 (0.112 inch) through 5/8 (0.625 inch)	Carbon Steel
MS51848, Washer, Lock-Helical Spring, Hi-Collar	#0 (0.060 inch) through 1.000 inch	Carbon Steel CRES

075-5.7.2.1 Material Compatibility. Threadlocking compounds may be used with all metals, glass, ceramics, and many thermoset plastics such as phenolic, polyester, and nylon. They will soften and sometimes craze (etching, shallow cracking) thermoplastics, however, including ABS, polycarbonate, vinyl, and methacrylate. They will also soften varnish and lacquer finishes. Most baked enamel finishes are not harmed by initial contact with threadlocking compounds but should be wiped clean within 1 hour. The cured compounds will not affect any of the above materials.

075-5.7.2.2 Cleaning and Surface Activation Requirements. All parts must be chemically cleaned and have active surfaces to achieve reasonable cure times and proper strength. Never apply the locking compounds to oily surfaces or surfaces that have only been cleaned with diesel oil or solvents that leave a thin film after drying. Primers are available from the locking compound manufacturers that activate the thread surface and also contain some trichloromethane as a solvent. These primers will provide a clean and active surface when used as directed on the container. Nevertheless, preliminary cleaning should still be done using an approved shipboard solvent, after which the parts can be wiped dry and the primer applied.

075-5.7.2.3 Anaerobic Compound Cure Time. Anaerobic threadlocking compounds begin to cure on an active surface as soon as they are deprived of contact with air. The time required to complete the initial stage of curing, or the point at which the compound is no longer liquid, is referred to as fixture time. Fixture time varies from 15 seconds to 30 minutes, depending on the grade of primer used and the ambient temperature. Full curing requires much more time. Full cure on steel without a primer requires approximately 24 hours at 72°F. Curing time is halved for every 20°F increase and doubled for every 20°F decrease in temperature.

075-5.7.2.4 Fastener Material Curing Characteristics. Anaerobic compounds will cure to some extent on almost any clean metal surface, but proper curing requires what is called an active surface, or an activator or heat applied to an inactive surface, or both. [Table 075-5-4](#) shows common active and inactive surfaces.

075-5.7.2.5 Primers (Activators). Primers are available that will activate inactive material surfaces and accelerate the curing process within different times.

075-5.7.2.6 Assembly Time Requirements. Grade N is a general purpose primer. Fixture time with this primer is approximately 30 minutes, with full cure of the compound achieved in 24 hours. Grade T primer is a fast-curing primer that will provide a full cure in 6 hours. Fixture time with grade T primer is approximately 5 minutes. [Table 075-5-5](#) lists some of the NSNs that may be used for procuring these primers in grades N and T. For special applications that require faster curing times, grade NF 736 primer with a cure time of 4 hours is available, but this primer requires great caution, since fixture occurs within 15 seconds and final tightening within a total of 30 seconds following application of the primer. The grade NF 736 primer may be obtained commercially. Use is subject to approval on a case basis. Primers to MIL-S-22473 can be used with anaerobic compounds to MIL-S-46163.

075-5.7.2.7 Using Heat to Cure. Heat can also be used to activate and accelerate the curing process. Complete cure will occur in 1 hour, provided the bond line temperature is held at 200°F to 250°F during that period. The use of heat may be an impractical way to accelerate curing unless special heating equipment is available, the fastener is readily accessible, and the component can accept the heat. Do not try to use a torch, as the temperature cannot be controlled accurately and the heat has to be applied for an hour.

075-5.7.2.8 Tightening Chemically Locked Fasteners. All threaded fasteners treated with anaerobic compounds should be assembled and given their final torquing while the compound is still liquid. When tightened wet, the fastener will have essentially metal-to-metal contact of the load bearing thread surfaces after curing. This provides a stronger joint and reduces the tendency of the initial fastener preload to relax with time. An additional benefit is that the compound, in its liquid form, acts as a lubricant to help achieve the proper fastener preload.

Table 075-5-3 LISTING OF ANAEROBIC COMPOUND TO MIL-S-46163

NSN (8030)	Type	Grade	Container	Size	Loctite No.
00-148-9833	I	K	10-Plastic Squeeze Bottles	10 cc each	271
01-158-6070	I	K	Plastic Squeeze Bottle	50 cc	271
01-063-7510	I	L	Plastic Squeeze Bottle	50 cc	277
01-054-3968	II	M	Plastic Squeeze Bottle	10 cc	222
01-069-3046	II	M	Plastic Squeeze Bottle	50 cc	222
01-055-6126	II	M	Plastic Squeeze Bottle	250 cc	222
01-104-5392	II	N	Plastic Squeeze Bottle	10 cc	242
01-014-5869	II	N	Plastic Squeeze Bottle	50 cc	242
01-025-1692	II	N	Plastic Squeeze Bottle	250 cc	242

Table 075-5-4 COMMON ACTIVE AND INACTIVE SURFACES

Active Surfaces	Inactive Surfaces (use activator primer)
Soft Steel or Iron	Bright Platings
Copper	Zinc
Brass	Anodized Surfaces
Manganese	Pure Aluminum
Bronze	Passivated Surfaces
Nickel	Stainless Steel
Commercial Aluminum (containing copper)	Titanium
	Cadmium
	Magnesium
	Plastics
	Natural or chemical black oxide on steel

Table 075-5-5 LISTING OF PRIMERS (ACTIVATORS) TO MIL-22473

NSN (8030)	Grade	Container	Size
00-082-2508	T	Bottle	4 oz
00-083-3442	T	Can	1 gal
00-181-8372	T	Aerosol Can	6 oz
00-900-2373	N	Bottle	4 oz
00-935-5816	N	Can	1 gal
00-980-3975	N	Can	6 oz

075-5.7.2.9 Tightening of Studs Set with Chemicals. Studs must be set while the locking compound is still liquid. Care should be taken to ensure the proper stud stand-out is maintained since little adjustment can be made after the compound has become fixed which requires 15 seconds to 30 minutes depending upon the primer used. Normally, the joint should not be assembled until the locking compound has cured which can take up to 24 hours if primers are not used. Using grades T or NF 736 primer will reduce the waiting times to 6 and 4 hours, respectively. Where heat at 200° to 250°F can be applied to the bond line and held between the specified limits, the waiting period can be reduced to 1 hour.

075-5.7.2.10 Threadlocking Compound Selection. Base selection of the specific compound on the type and material of the fastener on which it is to be used and the desired end result. Five variables are involved in the selection process: fastener type, fastener material, service temperature, required breakaway and prevailing torque (locking torque strength), and size of gap (class of thread fit) to be filled.

075-5.7.2.10.1 Standard Anaerobic Threadlocking Compounds. Unless otherwise specified, or where some unusual requirement exists, most shipboard threadlocking needs can be satisfied by one of the following anaerobic compound grades (or equivalent MIL-S-24733 grades):

- a. MIL-S-46163 Type II, Grade M, (purple); 300°F service temperature, low strength, permits some fastener adjustment after curing, removable with hand tools, suitable for 1/4-inch and smaller fasteners.
- b. MIL-S-46163 Type II, Grade N, (blue); 300°F service temperature, medium strength, general purpose, removable with hand tools, suitable for fasteners larger than 1/4 inch. This is the most commonly used grade.

- c. MIL-S-46163 Type I, Grade K, (red); 300°F service temperature, high strength for fasteners up to 1 inch, permanent locking, requires heat (500°F) and hand tools to remove.
- d. MIL-S-46163 Type I, Grade L, (red); 300 °F service temperature, high strength for fasteners over 1 inch, permanent locking, requires heat (500°F) and hand tools to remove.
- e. NSN 8030-01-171-7628, (red); 450°F service temperature, high strength, permanent locking, requires heat (500°F) and hand tools to remove.

075-5.7.2.10.2 Fastener Type. For the purpose of selecting the proper grade of anaerobic thread locking compound, all threaded fasteners fall into one of the three following types: studs, fasteners 1/4-inch and smaller, and fasteners larger than 1/4 inch.

- a. Studs. Unless otherwise specified, studs that must have their set end locked may be locked with an anaerobic threadlocking compound instead of a class 5 fit, provided that a class 2 to 3 thread fit is achieved and the requirements for cleaning, priming, temperature, and curing are met.
 - 1 The purpose of locking the set end of a stud is usually to enable the self-locking nut on the opposite end to be removed without backing the stud out of its tapped hole. To this end, use MIL-S-46163 Type II, Grade N, as its breakaway torque is greater than that of a reusable self-locking nut. Where greater locking torque strength or permanent locking is required, use NSN 8030-01-171-7628.
 - 2 NSN 8030-01-171-7628 requires the application of heat (500°F) for removal. If these temperatures cannot be applied safely, the stud may have to be drilled or otherwise machined out for removal.
- b. Small Fasteners. Lock fasteners 1/4 inch and smaller with a low-strength compound such as MIL-S-46163, Type II, Grade M.
- c. Large Fasteners. Lock fasteners larger than 1/4 inch with a medium-strength compound such as MIL-S-46163 Type II, Grade N.

075-5.7.2.10.3 Fastener Material. The locking torque strength of the anaerobic compound is partially dependent on the material of the fastener to which the compound is applied. Most torque strength data are based on the use of uncoated steel fasteners, which have a naturally active surface. Anaerobic compounds used on a zinc-coated fastener will develop only 70 percent of the torque strength of compounds used on a bare steel fastener; those used on an aluminum fastener will develop only 30 percent of the torque strength of compounds used with steel. Other nonferrous materials have similar properties. To get the best locking with all materials, always use a primer that will ensure a clean active surface (see paragraph [075-5.7.2.2](#)).

075-5.7.2.10.4 Service Temperature. The service temperature for the fastener (design operating temperature) can be determined from the system or component specifications. If the service temperature is between -65°F and +300°F, most of the locking compounds will give satisfactory service over this temperature range. Where permanent locking is acceptable for non-nuclear applications, NSN 8030-01-171-7628 can be used between -65°F and +450°F.

075-5.7.2.10.5 Locking Torque Strength. The locking torque strength required is usually determined by the following three considerations:

- a. Do you need to disassemble the fastener or remove the stud?
- b. Can heat (500°F) be applied to the fastener?

c. Is a fastener preload specified?

The first consideration is based on maintenance requirements and usually is obvious. The second depends on the fastener material and on determining whether heating the fastener would damage the equipment. If a minimum preload is specified, locking compounds with a breakaway torque lower than the prevailing torque are unacceptable. The anaerobic threadlocking grades listed in paragraph 075-5.7.2.10.1 all have acceptable breakaway torque to prevailing torque ratios.

075-5.7.2.10.6 Gap Size (Class of Thread Fit). The gap size is determined by the class of thread fit. Studs are usually permitted to have a class 2 fit on their set end, but some applications specify a class 3 fit. All other shipboard threaded fasteners have a fit at least as tight as class 2. The anaerobic threadlocking grades listed in paragraph 075-5.7.2.10.1 will all fill the gaps associated with class 2 and tighter fits satisfactorily.

075-5.7.2.10.7 Inspection of Studs Set with Anaerobic Compounds. If no other guidance is provided, studs should be subjected to a torque inspection test following installation. The inspection torque applied is to provide assurance that the studs will not turn with normal nut installation and removal. The torques listed in Table 075-5-6 are essentially the maximum breakaway torque permitted for MIL-N-25027 self locking nuts. Normally, the joints will withstand much higher torques which are dependent upon the anaerobic compound used and the depth to which the stud is set. Inspection shall be in accordance with the following:

1. Allow the compound to cure for the time specified in paragraph 075-5.7.2.3.
2. Select the proper stud or studs for testing, one from a group of three or less or two from a group of four or more. Where two are selected they should be approximately 180 degrees apart.
3. On the stud to be tested, install a stud removal tool that grips the threads without damaging them. Apply the inspection torque from Table 075-5-6 in the direction that would loosen the stud. Stud removal tools are listed in the Afloat Shopping Guide under FSC 5120. If a stud removal tool is not available, double nuts may be used. The material of the nuts selected shall have low galling potential. ASTM A 194 Grade 7 or equivalent nuts are recommended for inspection of both ferrous and non-ferrous studs.
4. If the stud does not rotate on the application of the torque, installation of that stud is satisfactory. The stud installation is also satisfactory if the stud does not rotate more than 1/4 turn.
5. If any stud rotates more than 1/4 turn, every stud in the group shall be inspected and all which rotate more than 1/4 turn shall be removed, reinstalled. The reinstalled studs shall be subject to reinspection starting with step 1 above.

Table 075-5-6 PROOF TORQUE VALUES FOR FASTENERS INSTALLED WITH ANAEROBIC COMPOUND

Fastener Diameter (inches)	Torque (ft-lb) ¹	Fastener Diameter (millimeters)	Torque (N-M) ²
1/4	2.5	3	0.6
5/16	5	4	1.2
3/8	6.7	5	2.1
7/16	8.3	6	4.0
1/2	12.5	8	9
9/16	17	10	14
5/8	25	12	21

**Table 075-5-6 PROOF TORQUE VALUES FOR FASTENERS INSTALLED
WITH ANAEROBIC COMPOUND - Continued**

Fastener Diameter (inches)	Torque (ft-lb) ¹	Fastener Diameter (millimeters)	Torque (N-M) ²
3/4	33	14	31
7/8	50	16	42
1	67	20	72
1-1/8	75	24	106
1-1/4	83	30	140
1-3/8	100	36	180
1-1/2	115		
1-3/4-5	150		
1-3/4-8	160		
2	180		
2-1/4	215		

¹ Ft-lbs may be converted to Newton-Meters by multiplying by 1.356.
² Newton-Meters may be converted to ft-lbs by multiplying by 0.738.

SECTION 6. THREADED FASTENER REMOVAL

075-6.1 GENERAL

075-6.1.1 CONTROL. As the complexity and sophistication of ships increase, it becomes more and more important to treat threaded fasteners carefully. When fasteners are removed during equipment overhaul or repair, or for inspection, and are to be reused, a suitable control system for identifying, stowing, and handling them is required (i.e., tag and bag). This is important because some uniform strength fasteners used for equipment hold-down or other applications designed for HI shock are identical to or closely resemble standard fasteners (see paragraph 075-2.8.2 for further information on identifying uniform strength fasteners). Some applications, such as fitted bolts or class 5 interference fit studs, require that each fastener be identified by the hole from which it came.

075-6.1.2 LEFT-HAND THREADS. Most threaded fasteners have right-handed threads which are turned clockwise to tighten and obviously should be turned counter-clockwise to loosen. Some fasteners used on rotating elements of machinery, however, may use left-hand threads to prevent the fastener from loosening during operation. Pay particular attention to these areas and look carefully at the hand of the thread before loosening the fasteners. If you can't see any of the thread, examine the bolt head or nut for some kind of identification such as the letters LH or L, which denotes a left-hand thread. If the hand of the thread is not obvious, check the equipment manuals, technical manuals, and drawings. If you can find the number, check the APL for a replacement, it may give the hand. If none of these approaches work, then try to turn the fastener with a torque wrench. Start by trying to turn the fastener opposite to the direction of the component's rotation. Apply the torque slowly and build up to the value given in Table 075-4-1 for the fastener size in question. If the fastener turns but the torque required to turn it is increasing, then you are probably turning it the wrong way. Stop and try the other way and it should loosen. There is usually some margin in the specified torque values and you will not damage the fastener by exceeding the specified torque by 10%.

075-6.1.3 AVOIDING PROBLEMS. Don't let little mistakes lead to major problems. Few things are more frustrating than rounded-off wrench flats and broken studs or capscrews. Although there will always be some of these problems, you don't have to make a career out of them. A few simple precautions will greatly reduce the number of damaged fasteners and knuckles.

075-6.1.3.1 Plan Your Job. Examine the fasteners that you have to remove. Look for rust and corrosion. If you find it, clean off as much of the dirt, paint, and rust as you can so that you can get down to the threads and the joint between the fastener and its bearing surface. Apply penetrating oil and let it soak in. Penetrating oils are listed in the Afloat Shopping Guide (ASG) under FSC 9150. For propulsion plant equipment in nuclear powered ships, only penetrating fluid per MIL-P-24548 can be used. If the equipment will not be damaged, tapping on the fastener with a hammer will help the penetration. Make sure that you get your wrench all the way on the nut or head and pull on the wrench at as close to a 90-degree angle to the fastener centerline as you can. If you're working with a nut and bolt, turn the nut, not the bolt. If at all possible, use a 6-point socket or box-end wrench; they are far less likely to round off the corners. Open end wrenches are for fasteners located where you simply can't get a socket or box-end wrench on them. Twelve point socket and 12 point box-end wrenches are for special fasteners that require a 12 point wrench or socket.

075-6.1.3.2 Think Safety. Make sure that you hold the wrench on the nut straight and pull straight, if you don't, there is a good chance that the wrench will twist and round off the corners. There is also a good chance you will hurt yourself. Look at where your hand or your head will end up if the wrench slips or if the fastener breaks loose suddenly. If you see a problem, reposition the wrench or protect yourself with a rag.

075-6.1.3.3 Stubborn or Damaged Fasteners. After you have made the initial preparations outlined in the preceding two paragraphs, you are ready to start. If you suspect that the fastener is stuck, or if you have tried it and it is stuck, try an impact wrench with a six-point impact socket. The impact load will put more load on the nut than a steady pull will. Manual Impact Wrenches are listed in the ASG under FSC 5120. If this doesn't work see [Section 9](#) for information on removing damaged or stubborn fasteners.

075-6.1.4 NORMAL REMOVAL. Most threaded fasteners are removed with ordinary hand tools: box and open-end wrenches or socket wrenches. The job will always go smoother if you use the best tool for the job. You'll waste more time and a lot more energy struggling with a wrench that's too short than you will in going to your tool box and getting one with a long enough handle. Get a long handle breaker bar for your socket set and use it. If you can get a power-driven nut runner, treasure it and use it; break the nut loose with the breaker bar and use the nut runner to remove it. Don't use an open-end wrench when you have a socket wrench and a ratchet handle that will fit. Use 3/8-drive sockets wherever you can; they are a lot easier to use overall.

075-6.1.4.1 If you are working with large fasteners, use large wrenches. Get 1-inch drive sockets; don't fool around with 2-inch diameter sockets on a 1/2-inch drive handle. If you have several large fasteners to loosen, get a 1-inch drive impact wrench and a six-point impact socket.

075-6.1.4.2 If you can turn the fastener but it's difficult because of rust or corrosion, don't keep turning until it seizes. Use penetrating oil to break down the rust and reduce thread friction so that you can remove the fastener without a major problem. For propulsion plant equipment in nuclear powered ships, only penetrating fluid per MIL-P-24548 can be used. Apply the chemical liberally to the thread area and to the bearing surface. Turn the fastener back a little bit and then apply more chemical. Once the fastener starts to turn more freely, apply

more chemical and work the fastener back and forth. This will work the chemical into the thread area and you should then be able to remove the fastener. It helps to let it soak for several hours to allow the chemical to seep into the smallest cracks.

075-6.1.4.3 Several commercial products are on the market that are not corrosive and work well. They can be obtained from the ship's supply system or by local purchase. When using such products, observe the manufacturer's cautions and directions printed on the container. Some products contain corrosive chemicals that accelerate the corrosion of some metals with which they come in contact. Since these products tend to seep into small cracks and inaccessible areas and cause further damage, don't use them. Check the label on the container or ask the supplier about the potential corrosive nature of the products. Removing damaged or especially stubborn fasteners is detailed in [Section 9](#) of this NSTM chapter.

075-6.1.5 REMOVAL OF CHEMICALLY LOCKED FASTENERS. Fasteners locked with an anaerobic compound can be disassembled by one or a combination of the following methods: applying high torque, applying heat, applying chemicals.

075-6.1.5.1 Using Torque to Loosen. First apply torque in excess of breakaway values (short of breaking the fastener) to break down the compound. Then, continue to apply torque at prevailing torque levels until the fastener is apart.

075-6.1.5.2 Using Heat and Torque to Loosen. If the above method does not loosen the fastener, apply heat to the fastener and continue to apply loosening torque. The compound will soften appreciably or decompose at 500°F.

075-6.1.5.3 Using Chemicals and Torque to Loosen. Chemicals are available which will loosen anaerobic compound. However, their use is generally prohibited aboard ship because of environmental or personnel hazards.

CAUTION

When applying heat, make sure that the heat applied will not damage the equipment, nearby seals or gaskets, or present a fire hazard. If you've applied chemicals to soften that locking compound, wash them off with appropriate solvents and dry the area before applying heat.

075-6.1.5.4 Nonanaerobic Locking Compounds. You may encounter many nonanaerobic locking compounds, and identifying them may be impossible. In any event, the procedures described above usually works for them also.

SECTION 7.

INSTALLATION OF THREADED FASTENERS

075-7.1 GENERAL

075-7.1.1 If you are only replacing undamaged fasteners removed for some inspection or repair operation, selecting the proper threaded fastener system is simple. Put the old fasteners back in the same joint they came

out of and tighten them to the proper preload. The only potential problems here are: Which joint did which fastener come out of? What is the proper preload? and How are you going to measure the preload? Have you ever had to put a piece of equipment back together that someone else took apart? If you have, then you can understand the importance of tag and bag. The fasteners used for a particular joint should be thought of as a threaded fastener system. It takes the right combination of nuts, bolts, washers, locking devices, and joint design to ensure proper joint performance. Since you may not be the first person to take down a particular joint you should be alert to the possibility that the fasteners that are now in the joint may not be the correct ones. Check the ship's equipment and component APLs, and the technical manuals or component drawings before you start the job to see what fasteners you can expect to find. If you are working on a MIC Level I system, the quality assurance (QA) department must become involved in the overall job and with all new material taken from the MIC Level I supplies (see paragraph [075-3.2.1](#)).

075-7.2 FASTENER SELECTION PROCEDURE

075-7.2.1 If possible, obtain technical input from NAVSEA using [Table 075-3-7](#). When no other guidance is available, use the following:

1. Check max operating temp of system fastener will be exposed to.
2. Determine material fastener is clamping.
3. Select material which is suitable for the application.
4. Verify material selected can withstand operating temps.
5. Determine clamping force needed and select the fastener having sufficient strength greater than needed.
6. Select size, shape, & type fastener per other section of manual.
7. At next availability, obtain tech assistance to verify selection.

The following paragraphs discuss several specific topics related to the proper selection of fasteners. In addition, refer to [Section 2](#) and [Section 3](#) of this chapter for guidance on identifying fasteners, [Section 4](#) for guidance on tightening fasteners, and [Section 5](#) for guidance on locking threaded fasteners.

075-7.3 FIVE BASIC SITUATIONS

075-7.3.1 GENERAL. There are five basic situations that you will encounter in installing fasteners: 1) the original fasteners were removed without damage to them and were properly tagged for reinstallation, 2) there are damaged fasteners, 3) fasteners are missing, 4) the fasteners were not tagged for reinstallation, or 5) a combination of the above. There is an additional consideration that is common to each of the five basic situations: Are the fasteners you have now the correct ones, or were they mixed up during previous maintenance? When trying to identify lost or damaged fasteners, keep in mind that there is usually more than one fastener of the same type in a particular piece of equipment. Pipe line flanges, cover plates, pump casings, cylinder heads, connecting rods, and pipe hangers all have more than one fastener. Look at the remaining fasteners and see if they have legible markings, or look at the same equipment in another space on your ship or on another ship. You can then identify the fastener and get a new one.

075-7.3.2 NEW EQUIPMENT. If the component is new or has not been previously disassembled and the equipment or component has not experienced problems with leakage, breakage, or corrosion, you can be reasonably certain that its fasteners were the proper ones for the job. Check the machinery history records for any pre-

vious maintenance or modifications. If the fasteners were removed without damage and properly controlled (tagged and bagged), inspect them as described in paragraph 075-8.3, and then reinstall the fasteners using the installation procedures outlined in this section.

075-7.3.3 DAMAGED FASTENERS. If the original fasteners have been damaged, see paragraph 075-8.5 for thread repair procedures.

075-7.3.4 UNREPAIRABLE FASTENERS. For damaged fasteners that cannot be repaired, check Allowance Parts Lists to see if replacement fasteners are identified. If not on the APL, next check technical manuals or component drawings. If you have these documents, the correct replacement fastener can be determined and a new one obtained through the supply system. If you do not have these documents, inspect the original fastener for markings in accordance with paragraph 075-3.3.2 and Table 075-3-1. The markings will enable you to determine the material and grade of the previously installed fastener. If you have experienced no previous problem (leakage, breakage, or corrosion), you may use the same type fasteners as those removed as a temporary replacement fastener, while you try to obtain further documentation. If you cannot read the markings, see paragraph 075-7.3.5 below.

075-7.3.5 UNIDENTIFIABLE FASTENERS. If you cannot identify the correct fastener to be installed because: 1) the original fasteners have been lost, 2) the original fastener was not the proper one for the application, 3) the technical documentation does not have the necessary information, 4) the needed fastener cannot be identified by inspecting similar equipment, or 5) the original fasteners have no markings; refer to Section 2 for help in selecting an acceptable, temporary replacement fastener. Also, you may utilize the Inquiry & Technical Response Record Form (Table 075-3-7) to obtain technical assistance by facsimile transmission.

075-7.3.5.1 Determine the required fastener diameter, number of threads per inch, and length by measuring the original fastener; or measure the hole diameter, thickness of parts to be clamped, and assume a UNC Class 2A and 2B fit unless evidence indicates otherwise.

075-7.3.6 USE OF TEMPORARY FASTENERS. When temporary fasteners are used in accordance with paragraph 075-8.5, prepare a work request requesting a review of the replaced fastener at the next opportunity.

075-7.4 SELECTION OF PROPER THREADED FASTENER SYSTEMS

075-7.4.1 THREADED FASTENER SYSTEM. There is more to most bolted joints than just a nut and a bolt. A number of different elements usually make up a particular bolted joint. The proper combination of the following basic elements, taken together, make up the fastener system for a particular joint.

- a. A capscrew, bolt, stud, or bolt-stud.
- b. One or more nuts.
- c. One or more washers.
- d. One or more threadlocking devices.
- e. One or more different chemical locking compounds.
- f. Tapped holes.
- g. Thread inserts.

- h. Design requirements for the joint such as service temperature and pressure, gasket type (sealing), gasket material "hardness", joint materials, thread engagement length available, clearance or metal-to-metal contact joint faces, location environment (weather, bilge, shock grade, fire hazard).

You must address each of the remaining topics in [Section 7](#) to be sure that all of the required components are properly installed.

075-7.4.2 TECHNICAL MANUALS AND SYSTEM DRAWINGS. The first step in performing any maintenance or repair operation on a piece of equipment is to READ THE INSTRUCTIONS. The second step is to FOLLOW THOSE INSTRUCTIONS. If you have the necessary manuals and drawings, then you can proceed and expect the job to be completed successfully.

075-7.4.3 UNAVAILABILITY OF TECHNICAL MANUALS. If the necessary technical manuals or drawings are not available, the topics in the remainder of [Section 7](#) will enable you to properly install a safe fastener system until you can get the required specifications and either verify that what you did was satisfactory or make the necessary changes.

075-7.5 LENGTH OF THREAD PROTRUSION

075-7.5.1 MINIMUM THREAD PROTRUSION. A minimum thread protrusion length is given to ensure that all the threads are engaged. This is required to ensure a full-strength fastener. Equipment component drawings should specify the type, length, and size of bolt, stud, bolt-stud, etc. to be used to obtain the proper thread protrusion. If not specified on the drawings, threaded fasteners of commercially stocked lengths should be used. Threaded fasteners, when installed and tightened, should protrude a distance of at least one thread beyond the top of the nut or plastic insert. Excessive protrusion should be avoided, particularly when necessary clearances, accessibility, and safety are important. Thread protrusion is considered excessive if it could cause damage to machinery or harm to personnel. Where practicable, the number of threads protruding should not exceed five. In no case should thread protrusion exceed ten threads. In the case of a stud, excessive thread protrusion may indicate that the stud has not been properly driven in the blind hole. In self-locking nuts where the distance from the top of the nut to the locking element (plastic insert) is equal to or greater than the chamfer, the bolt or stud end may be flush with the top of the nut. For existing or reused fasteners where the thread protrusion exceeds 10 threads, verification should be made that the proper length fastener was installed. For existing installations utilizing standard nuts, acceptable minimum thread protrusion would be where the male thread, below any unthreaded chamfer or crown, is flush with the top of the nut. Washers should not be added to reduce protrusion except as specifically required by equipment component drawings or technical manuals.

075-7.5.2 MAXIMUM THREAD PROTRUSION. There is no maximum thread protrusion from the standpoint of the function of the fastener. Obviously, too much is a waste of material and weight. There is also a safety problem from long, sharp, threaded rods sticking out from equipment, and protruding threads can get in the way of other parts of the equipment. A good rule to follow is to always use the shortest standard length fastener that gives a minimum one thread protrusion. Small and/or short bolts come in 1/8- or 1/4-inch increments. As the fastener gets larger and longer the increments change to 1/2 inch. Up to a five-thread protrusion from a fastener is certainly reasonable, you shouldn't take a hacksaw to it for that; but if you have ten or more threads, you could probably have done a better job of selecting the length. There is no requirement to reduce the length of protrusion of existing fasteners before reinstalling them. There is also no reason you cannot cut off excess protrusion if it is obviously too long or in the way. However, you cannot use washers solely to reduce thread protrusion.

075-7.6 DEPTH OF ENGAGEMENT FOR STUDS AND CAPSCREWS

075-7.6.1 DETERMINING REQUIRED DEPTH OF ENGAGEMENT. The proper depth of engagement for studs and capscrews depends on several factors. The primary consideration is the relative strength of the stud and the material into which it is set. The set depth has to be greater when you are setting a high strength stud, such as ASTM A354 grade BD or K-Monel, into mild steel than when you are setting it into HY-80, if you want to develop the full strength of the fastener. Likewise, you do not need as great a set depth when you are setting a low-strength fastener into high-strength material; however, the set depth does have to be deep enough to grab enough of the stud threads to develop the full stud strength.

075-7.6.2 Where specific data is not available from equipment manuals or drawings, use of [Table 075-7-1](#) and the following procedure from FED-STD-H28 is recommended:

- a. When the ultimate strength of the stud or capscrew and the tapped hole material are similar, use the dimensions given in [Table 075-7-1](#).
- b. When the ultimate strength of the stud or capscrew and the tapped hole material are dissimilar, determine the material strength ratio R_2 where

$$R_2 = \frac{\text{tensile strength of tapped material}}{\text{tensile strength of screw material}}$$

If R_2 is less than R_1 in [Table 075-7-1](#), multiply the required length of engagement given in [Table 07-7-1](#) by R_1 / R_2 . The tensile strength of fasteners made of various materials is given in [Table 075-3-1](#) of [Section 3](#) of this chapter.

075-7.7 SQUARENESS OF SPOTFACE WITH HOLE

075-7.7.1 FASTENER-BENDING LOADS. The bearing surface of bolt heads and nuts should always set flat on the bearing surface of the component in which they are used to keep from putting a bending load on the bolt. Bolts and studs do not take bending loads well. If a fastener already has a large tensile load, the addition of a relatively small bending load can cause it to fail.

Table 075-7-1 REQUIRED DEPTH OF ENGAGEMENT FOR TAPPED HOLES

Thread Designation	Minimum Required Length of Engagement	* R_1
1/4-20 UNC 2A	0.1566	0.8552
5/16-18 UNC 2A	0.2037	0.8723
3/8-16 UNC 2A	0.2466	0.8745
7/16-14 UNC 2A	0.2891	0.8677
1/2-13 UNC 2A	0.3331	0.8743
9/16-12 UNC 2A	0.3765	0.8737
5/8-11 UNC 2A	0.4163	0.8704
3/4-10 UNC 2A	0.5064	0.8778
7/8-9 UNC 2A	0.5957	0.8781
1-8 UNC 2A	0.6814	0.8728
1-1/8-7 UNC 2A	0.7609	0.8634
1-1/4-7 UNC 2A	0.8576	0.8766

Table 075-7-1 REQUIRED DEPTH OF ENGAGEMENT FOR TAPPED
HOLES - Continued

Thread Designation	Minimum Required Length of Engagement	*R ₁
1-3/8-6 UNC 2A	0.9270	0.8618
1-1/2-6 UNC 2A	1.0233	0.8719
1-3/4-5 UNC 2A	1.1801	0.8599
2-4.5 UNC 2A	1.3438	0.8586
2-1/4-4.5 UNC 2A	1.5334	0.8711
2-1/2-4 UNC 2A	1.6913	0.8649
*R ₁ = Shear Stress Area Ratio R ₁ = Shear Area of External Threads over Shear Area of Internal Threads		

075-7.7.2 EFFECT OF BEARING SURFACE ON TORQUE LOAD. If the bearing surface is not square with the bolt hole, the bearing load will be uneven and may cause local galling or compression failure of the material. This will increase the force required to turn the fastener and also make it more difficult to develop the proper clamping force.

075-7.8 HEX-HEAD BOLTS AND CAPSCREWS

075-7.8.1 DIFFERENCES BETWEEN HEX-HEAD BOLTS AND CAPSCREWS. Bolts are intended for use with nuts. Hex-head bolts are the most common type although occasionally a square head bolt may be used in some applications. In general, square-head bolts are usually used only as cheap, low strength, temporary fasteners during ship construction. Do not install bolts into tapped holes, use a cap screw. Hex head capscrews are similar in appearance to hex head bolts but have tighter manufacturing controls on straightness and alignment of the bearing surface with the thread centerline. This is done to make it easier to screw the cap screw into a tapped hole and, as discussed in paragraph [075-7.7.1](#), minimize the bending moment on the fastener. Often cap screws are more readily available and less expensive than bolts. Accordingly, cap screws can be substituted for bolts of the same material. However, bolts should never be substituted for cap screws.

075-7.8.2 TYPES OF BOLTS. Bolts come in six basic configurations as shown in [Figure 075-7-1](#); roll-formed threads over their entire length, 2) cut threads over their entire length, 3) roll-formed threads on the end with a reduced shank diameter equal to the thread pitch diameter, 4) cut threads on the end with a full diameter shank, 5) cut threads on the end with the shank diameter reduced to the thread root diameter, and 6) cut threads on the end with an axial hole drilled through the head and down through the unthreaded portion of the shank to the beginning of the threads. Some of these configurations may also have a larger head-to-shank fillet radius and a more gentle transition from threads to shank. Be particularly careful not to interchange these different types of bolts, especially when working on engine cylinder head and bearing bolts, turbine casing bolts, or on foundation or hull integrity bolts. See paragraph [075-2.8.2](#) for a discussion on uniform or constant strength fasteners.

075-7.8.3 THROUGH BOLTS. The majority of bolts are used as through bolts; that is, they are inserted through the bolt holes of two or more items with the bolt head on one side and a nut on the other.

075-7.8.4 CAPSCREWS IN THREADED HOLES. There are many applications in which capscrews are installed in drilled and tapped holes. However, there are four major concerns associated with these applications.

- a. Ensuring adequate depth of thread engagement.
- b. Not bottoming or shouldering the bolt.
- c. Not stripping or otherwise damaging the threads in the tapped hole.
- d. Making sure that the hole is bottom-tapped and clean of all chips, dirt, and liquids.

075-7.8.4.1 Selecting Proper Screw Length. The first two concerns involve selecting the proper screw length. Make sure that you use a screw that is long enough to meet the minimum thread engagement required for the application (see paragraph 075-7.6), and yet not be bottomed out in the hole before developing the proper clamping force. Remember that, if you cut off part of the end of a screw to prevent it from bottoming, you may have to run the threads further up the shank to prevent shouldering the screw when you tighten it. Note that you cannot satisfactorily extend roll-formed threads by cutting as the shank is too small in diameter and the shallow threads that you do cut will weaken the fastener. Also, some screws are hardened after threading and any additional threading may not be practical.

075-7.8.4.2 Preventing Damage to Tapped Threads. The next concern, that of not damaging the tapped threads, is the driving force behind the requirement to use studs. If you use a stud, make sure that the hole is drilled and tapped deep enough and that the stud is set deep enough before the equipment parts are assembled. Then, if you have to disassemble the equipment, you do not have to remove the stud and run the risk of ruining a tapped hole which you may not be able to repair.

075-7.8.4.3 Cleaning the Tapped Hole. The last concern is to make sure that the hole is clean, all of the threads are sound, and full threads extend to the bottom of the hole. This may be difficult to do in some applications; you may need to use a bottom tap. Make sure that you are using the proper tap for the specified thread fit. For example, in the case of a 1/2-inch coarse thread hole, there are five different tap diameters available: class 1B, 2B, 3B, NC5 IF, and NC5 INF. Each of these taps is designed to produce a particular class of thread fit. Note that starting, plug, and bottoming taps do not produce different classes of fit, they only offer different tapers on the end to assist in starting the tap. See paragraph 075-8.5 for a discussion on cleaning up the various thread fits. After all thread inspection and repair has been done, clean the hole with an appropriate solvent and use a blow gun to dry it out.



- (1) Roll-formed threads over entire length

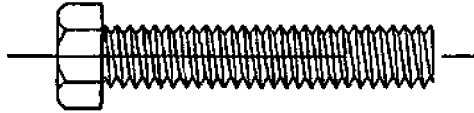

- (2) Cut threads over entire length



- (3) Roll-formed threads on end with reduced shank diameter equal to thread pitch diameter

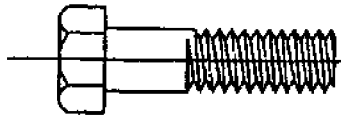

- (4) Cut threads on the end with full diameter shank

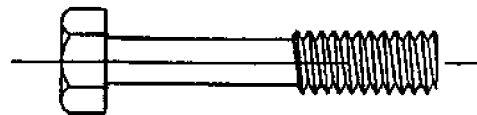

- (5) Cut threads on the end with shank diameter reduced to thread root diameter

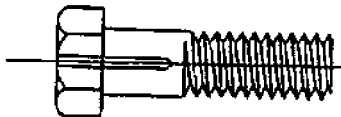

- (6) Cut threads on the end with an axial hole drilled through head and unthreaded shank

075-7-1 Types of Bolts

075-7.8.4.4 Use of Thread Locking, Lubricating, and Antiseize Compounds. Determine whether or not a chemical thread-locking compound will be needed. If it is needed, keep the hole clean and oil-free. The wet locking compound will serve as a thread lubricant while tightening the fastener. If no chemical locking compounds will be used, then either a thread lubricant or a combination lubricant and antiseize compound will be required. See paragraph [075-4.6](#) for information on proper thread lubricants and antiseize compounds.

075-7.9 FITTED BOLTS

075-7.9.1 WHY AND WHERE THEY ARE USED. Fitted bolts are special bolts designed to maintain equipment alignment and/or resist high shear loads. These bolts have a smoothly machined shank which is larger in diameter than the bolt threaded portion. For some applications that do not require a precise fit, a bolt with cut threads can be used, as the unthreaded shank of these bolts is slightly larger in diameter than the threaded portion (bolts with roll-formed threads cannot be used as fitted bolts due to their reduced diameter shank). Bolt-studs could also be used for these applications; however, it is not common practice.

075-7.9.2 HOLE PREPARATION. Bring the equipment into proper alignment and lock it in that position using the standard fasteners (bolt-studs and nuts). Drill the hole for the fitted bolts one drill size smaller than the desired fitted bolt size. A drill fixture should be used to make the holes square with the bearing surface. Then use either an expansion reamer or a series of straight reamers (ones with a slight taper on the starting end) to true up the holes and enlarge them to the desired size. Make sure that the final reaming is done with the material around the hole at room temperature.

075-7.9.3 FITTED BOLT PREPARATION. Measure the diameter of the previously prepared hole and have the machine shop prepare a fitted bolt in that same size for a size-on-size drive fit, or smaller, as required, to provide the desired clearance. If a precise fit is required, make sure that all final machining is done with the material at room temperature.

075-7.9.4 ALTERNATE FITUP PROCEDURE. Where standard size fitted bolts are available or where regular cut thread bolts are to be used, ream the hole to suit the bolt size. If you have easy access to the hole and it is easy to ream, you may want to fit the hole to the bolt in any case.

075-7.10 BOLT-STUDS

075-7.10.1 WHY AND WHERE THEY ARE USED. Bolt-studs can generally be used anywhere a bolt can be used. They are usually easier to install in tight quarters. Their primary advantage over bolts is greater fatigue resistance and higher absorption capability under high shock loads.

075-7.10.2 TYPES OF BOLT-STUDS. Bolt-studs come in five basic configurations (see [Figure 075-7-2](#)); 1) continuously threaded from end-to-end with roll-formed threads, 2) continuously threaded with cut threads, 3) roll-formed threads on each end with the unthreaded shank diameter in the middle equal to the thread pitch diameter, 4) cut threads on each end with a full diameter unthreaded shank in the middle, and 5) cut threads on each end with the unthreaded shank in the center reduced to the thread root diameter. Be particularly careful not to interchange these different types of bolt-studs, especially when working on engine cylinder head and bearing fasteners, or on foundation or hull integrity fasteners. See paragraph [075-2.8.2](#) for a discussion on the relative strengths and energy absorption capabilities of the five different types of bolt-studs shown in [Figure 075-7-2](#).

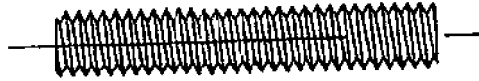

- (1) Continuously threaded from end-to-end with roll-formed threads

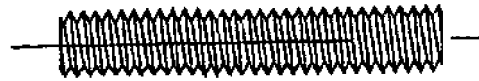

- (2) Continuously threaded with cut threads



- (3) Roll-formed threads on each end with unthreaded shank diameter equal to thread pitch diameter



- (4) Cut threads on each end with full shank diameter



- (5) Cut threads on each end with unthreaded shank equal to thread root direction

075-7-2 Types of Bolt Studs

075-7.10.3 TIGHTENING. When determining the length of a bolt-stud for a particular application, be sure to allow enough extra length for a temporary jam nut on one end. When you try to tighten a bolt-stud with a nut on each end, especially self-locking nuts, one nut will always thread on first. That nut will then become easier to turn and the other nut will not go on any further. At this point, run the first nut on far enough to allow a jam nut to be installed. Tighten the jam nut against the permanent nut and treat the assembly as if it were a bolt head. You will then be able to run the other nut on the other end and tighten it while holding the jam nut with a wrench. After tightening, remove the jam nut without disturbing the inner nut.

075-7.11 STUDS

075-7.11.1 WHY AND WHERE THEY ARE USED. The choice of using a stud instead of a bolt is a serious decision for the equipment designer. A stud is stronger than a bolt and its use is less likely to lead to equipment damage during maintenance (stripping or cross-threading) than a bolt. Studs generally have a slightly better energy absorption capability and hence a better resistance to shock than do bolts or cap screws. See paragraph [075-2.8.2](#) for a discussion on uniform strength fasteners

075-7.11.2 TYPES OF STUDS. Studs come in five basic configurations: 1) continuously threaded from end-to-end with roll-formed threads, 2) continuously threaded from end-to-end with cut threads, 3) roll-formed threads on each end with the unthreaded shank diameter in the middle equal to the thread pitch diameter, 4) cut threads on each end with a full diameter unthreaded shank in the middle, and 5) cut threads on each end with the unthreaded shank in the center reduced to the thread root diameter. There may be some applications where noncontinuously threaded studs will have a coarse thread on one end and a fine thread on the other. Where studs are set with class 5 interference fit threads, the set end will have the class 5 fit and the nut end will have a class 2 fit or sometimes a class 3 fit; this includes both the continuously threaded and noncontinuously threaded types. Studs are marked on the nut end and must be installed so that the marking is visible when the stud is set. See paragraph [075-2.8.2](#) for a discussion on the relative strengths and energy absorption capabilities of the different types of studs.

075-7.11.3 SETTING STUDS. There are two reasons for setting studs: 1) to prevent them from loosening during equipment operation (it does no good to use a locknut if you do not lock the stud into the tapped hole), and 2) to prevent them from coming out when you remove the nut (studs are used to prevent damage to tapped holes in equipment that could result from frequent removal of cap screws. For applications above the temperature limit for chemical thread locking compounds specified in Section [075-5.7](#), studs should be set with either a class 5 interference fit or if specified on the applicable drawings, by bottoming the stud. Class 5 fit studs are difficult to set properly, therefore, a chemical thread locking compound should be used instead of a class 5 fit when the temperature requirements for the allowed thread locking compounds specified in Section [075-5.7](#) are met.

075-7.11.3.1 Class 5 Fit. Preparing class 5 fit studs and tapping their holes is a job for someone with experience in this type of work. Except for emergency situations where you do not have any choice, leave this job for an expert. Where class 5 fit studs must be used, care must be taken to ensure that the proper thread fits are achieved or else the stud will either back out of the hole in service or seize before it is driven completely in. It is also very important that the hole to be tapped is drilled square with the mating surface. This means using a drill fixture to align and support the drill. You cannot do this with a hand-held drill. After drilling the hole, leave the drill motor in place and hold the tap in alignment with a lathe center drill installed in the drill chuck, or better yet, get the machine shop to make you a centering tool by machining a point on a short piece of 1/4 inch rod. Then start the tap with a wrench and maintain the alignment by following the tap down with the drill and centering tool. There is probably no practical way to cut satisfactory class 5 fit threads on a stud using hand tools

unless you have a high-quality die of the proper class and a die handle with a precise alignment collar. If you have access to more sophisticated drilling and threading equipment, use it.

075-7.11.3.1.1 There are many classes of interference fit threads. The proper combination of class and material must be used. Failure to do this may result in serious damage such as not being able to drive the stud deep enough, followed by breaking the stud off in the hole when you try to remove it. Paragraph [075-2.2.2.2.1](#) identifies recommended fits.

075-7.11.3.2 Nonstandard Class 5 Fit Threads. Be alert for nonstandard class 5 fit threads. A number of shipyards and repair facilities developed their own class 5 fit taps and dies before the current handbook H-28 and ASME standards were developed. If you have access to thread gauges and are familiar with their use, measure the existing hole threads and repair them as required. If not, you can use the standard class 5 taps and dies to determine what you have within reasonable limits. Start with the largest die or smallest tap and see if they will remove any metal. If they do not, change to the next size and try again. If the next size removes some metal, stop and go back to the last size as that is probably what you now have. Determine the material you have and use paragraph [075-7.11.3.1.1](#) to determine what fit you should have on the stud. Next, either install the stud if everything is within limits, or modify the stud and/or hole as required to meet the specified dimensions.

075-7.12 USE OF FLAT WASHERS

075-7.12.1 GENERAL. The bearing surfaces of most shipboard nut and bolt heads are washer faced and therefore do not require separate washers. However, where oversized or slotted holes are used for adjustment; thick, hard washers which cannot be deformed should be used. Some soft materials or thin-sheet metal covers will also require washers to distribute the bolt loads over a larger area. Here also, the washer must be thick enough and hard enough to distribute the load without being deformed itself. Some high-strength fasteners use a very thick, hard, slightly cup-shaped washer (belleville washer) to provide better preload control and some thread-locking capabilities.

075-7.12.2 WASHERS FOR EQUIPMENT SLIDING FOOT FASTENERS. Be careful when you are working with equipment holddown fasteners located in slotted or oversize holes designed to allow for thermal expansion of the equipment. These applications will have some sort of a bushing in the hole which is designed to permit tightening of the nut without restricting the sliding movement of the equipment. These bushings are often custom-fitted and must be checked to ensure that the equipment is still free to slide after the fastener is tightened. For these applications, a thick, hard washer is required so it cannot be forced down over the bushing, causing binding when the sliding foot tries to move.

075-7.13 INTERCHANGEABILITY OF NUTS

075-7.13.1 GENERAL. Many nut standards for plain hexagon nuts (see list below) do not distinguish between nuts that are "double chamfered" and those that are "washer faced" (see [Figure 075-7-3](#)). Therefore, when nuts are ordered from these standards either configuration may be received. However, the two configurations are completely interchangeable and substitution may be made without requesting prior authorization. The washer faced nut should be installed with the washer face toward the bearing surface.

075-7.13.2 STANDARDS FOR PLAIN HEXAGON NUTS WITH THE SAME PART NUMBER FOR DOUBLE CHAMFERED AND WASHER FACED CONFIGURATIONS. The following standards for plain

hexagon nuts lists the same part number for both the double chamfered and washer faced configurations: MS35690, MS35691, MS51471, MS51472, MS51473, and MS51971.

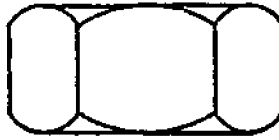

DOUBLE CHAMFERED



WASHER FACED

075-7-3 Nut Configurations

SECTION 8.

THREADED FASTENER INSPECTION AND REPAIR

075-8.1 GENERAL

075-8.1.1 This section covers the inspection and repair of threaded fasteners on board ship. Some threaded fasteners, such as equipment holddown fasteners and hull integrity fasteners, require periodic inspection for proper torque and overall condition. In general, fasteners are not removed for inspection unless the joint has to be disassembled for other reasons. All fasteners removed during overhaul and repair operations should be cleaned and inspected prior to reinstallation. Damaged fasteners found during inspection should be discarded and replaced with new ones. If no spares are available, temporary repairs should be accomplished as described in paragraph 075-8.5. When fasteners are removed during equipment overhaul or repair, or for inspection, and are to be reused; a suitable control system for their identification, stowage, and handling must be used (i.e., tag and bag). This is important as some constant strength fasteners used for equipment holddown, or other applications designed for high shock, are very similar in appearance to standard fasteners (see Section 3 for further information on identification of constant strength fasteners).

075-8.2 INSPECTION OF INSTALLED THREADED FASTENERS AND JOINTS

075-8.2.1 GENERAL INSPECTION. Inspect threaded fastener joints for missing fasteners or locking devices and for overall condition and tightness. Check for fasteners that are bent or cocked with respect to the hole centerline. Check for obvious looseness and, where required, check for proper torque.

075-8.2.1.1 Acceptance criteria for threads and self-locking fasteners:

- a. Cracks are not acceptable.

- b. Broken, chipped, or missing threads are not acceptable.
- c. Isolated minor defects are allowed. An isolated minor defect is a single nick, gouge, or flattened thread, (after removal of sharp edges and raised metal) that has a depth greater than 1/64 inch but less than 1/2 the thread height (depth) and a width less than the thread spacing (pitch). Defects less than 1/64 inch may be ignored.
- d. An isolated minor defect that exceeds the width criteria is acceptable when the total length of the defect does not exceed 15% of one thread length in any one complete thread. One complete thread or one thread length is defined as one complete rotation (360 degrees on a single thread), starting at a point along the thread.
- e. Any combination of minor defects is acceptable when the total combined length of the defects does not exceed 15% of one thread on one complete thread.
- f. Clearance fit threads must engage by hand.
- g. Self-locking fasteners must have a positive reinstallation torque. Cuts or tears in self-locking elements which are deeper than the existing thread impressions are not acceptable.

075-8.2.2 RUST AND CORROSION. Check for corrosion of the entire joint area as well as the fastener threads, nuts, and heads. A surface layer of rust or corrosion on a fastener is no cause for alarm but excessive corrosion may indicate a weakening of the fastener. Surface rust or corrosion should be removed and the affected areas preserved. Fasteners that have spalled areas or are pitted should be replaced.

075-8.2.3 THREAD PROTRUSION. Check to see that at least one thread protrudes beyond the top of the nut. See paragraph [075-7.5.1](#) for detailed discussion. Thread protrusion is also acceptable if the male thread, below any unthreaded chamfer or crown, is flush with the top of the nut. Excessive protrusion should be avoided, particularly when necessary clearances, accessibility, and safety are important. In the case of a stud, excessive thread protrusion may indicate that the stud has not been driven to its proper set depth. For existing or reused fasteners, there is no requirement to reduce the existing thread protrusion except where excessive protrusion could damage machinery or injure personnel. Generally, thread protrusion of more than 10 threads should be avoided.

075-8.2.4 TAB WASHERS. Inspect tab washers for missing tabs or cracks where the tab is bent, especially on the outside of the bend radius. Defective tab washers should be replaced (see paragraph [Section 5](#) for use of alternative locking devices).

075-8.2.5 CHECKING PRELOAD. In most cases, there is no way to accurately check the preload of an installed fastener without loosening it. However, where installed fasteners must be checked for proper torque, the only practical technique is to use a torque wrench (see paragraph [Section 4](#) for proper torquing procedures). When a loose fastener is encountered, the temptation is to simply retorque it to the specified value. This approach may be acceptable in a few noncritical cases but, unless threads are cleaned and lubricated and proper torquing procedures followed, there is no assurance that the preload will be restored. Therefore, if a fastener is loose, or if insufficient preload is suspected, remove the fastener, clean and lubricate the threads, and reinstall the fastener tightening it in accordance with the procedures in [Section 4](#). Whenever it is suspected that a fastener has been overtightened (excessively yielded), it should be discarded and a new one installed. There is no practical way to visually determine if minute cracks exist and to nondestructively determine if a fastener has been subjected to excessive strains.

075-8.3 VISUAL EXAMINATION OF FASTENERS PRIOR TO INSTALLATION

075-8.3.1 INSPECTING FOR PROPER APPLICATION TYPE. First, check fastener for markings. See [Section 3](#) for instructions on interpreting fastener markings and information on fastener selection.

075-8.3.2 HEAD DAMAGE. Check for head damage. If a fastener has been used, identifying markings may have been obliterated, or the hex flats may have been rounded such that a wrench cannot tighten the fastener without slipping. If head damage is found, replace the fastener. Check the bearing surface for burrs or other damage that would increase friction when tightening. Minor damage to the bearing surface can be repaired by use of a fine stone. Be careful not to scratch or nick the fillet where the head joins the shank. If severe damage exists, replace the fastener. Check the fillet where the head joins the shank for cracks or nicks. If any are found, replace the fastener.

075-8.3.3 RUST OR CORROSION DAMAGE. A surface layer of rust or corrosion on a fastener is no cause for alarm, but excessive corrosion may indicate a weakening of the fastener. Surface rust or corrosion should be removed and the affected areas represerved. Fasteners that have spalled areas or are pitted should be replaced. Fasteners that show signs of coating failure, rust, or corrosion and are located in a corrosion-prone area should be replaced with new fasteners of appropriate materials or fasteners with appropriate protective coatings (see [Section 2](#) for selection procedures).

075-8.3.4 OVERTIGHTENED (YIELDED) FASTENERS. Whenever you suspect that a fastener has been overtightened (excessively yielded), discard it and install a new one. There is no practical way to visually determine if minute cracks exist and to nondestructively determine if the fastener has been subjected to excessive strains.

075-8.3.5 THREAD FLATTENING. Check for thread flattening damage, where threads appear as flattened ridges instead of sharp ridges. This condition can be caused by improper installation or removal (see paragraph [075-8.5](#) for acceptable repair procedures).

075-8.3.6 SELF-LOCKING ELEMENTS. Check the condition of the plastic (nylon or vespel) locking elements in self-locking nuts. Replace self-locking nuts with loose or cracked elements and nuts with cracks in the metal surrounding the element.

075-8.4 ADDITIONAL EXAMINATIONS

075-8.4.1 GALLING. If a visual inspection does not indicate any apparent damage to an externally threaded fastener, run an undamaged nut onto the threads to check for galling. Galling is the tearing of the thread surfaces to the extent that metal is built up in small mounds making any further sliding action impossible. Depending on the extent of the galling, either filing the threads with a fine tapered thread file, using a lapping compound, or using a cleanup die-nut may relieve the condition (see paragraph [075-8.5](#)).

075-8.4.2 CHECKING SELF-LOCKING NUTS. Replace self-locking nuts which do not provide specified locking torque. [Table 075-5-1](#) provides minimum recommended breakaway torques for previously used self-locking nuts up to 2-1/2 inches in diameter.

075-8.5 THREAD REPAIR

075-8.5.1 GENERAL. Except for minor damage which can be repaired as described herein, replace damaged fasteners if spares are available. When replacement spares are not available, temporary thread repairs may be possible. Damaged internal threads in the tapped holes of equipment or structure, depending on the extent of the damage and type of material, may either be cleaned up or permanently repaired, either by grinding out all of the old threads, plug welding the hole and retapping or by using thread inserts.

WARNING

Use of a die-nut on Ni-Cu-Al- (K-Monel) fasteners is not recommended as this very hard material will wear the die out quickly.

075-8.5.2 THREAD REWORK. If a cleanup tap or die-nut of the appropriate size and fit is available, use it to rework slightly damaged threads and to remove stubborn foreign material where necessary.

075-8.5.3 THREAD FILING. Flattened or galled threads on externally threaded fasteners, depending on the extent of the damage, can sometimes be cleaned up with a fine tapered thread file. Extensive filing will reduce the strength of the fastener, but this is usually a minor consideration if less than 50 percent of the threads are involved. Be careful not to nick the root of roll-formed threads as it is the rounded and work-hardened root that gives these threads their extra strength.

075-8.5.4 THREAD LAPPING. For minor galling damage, apply a lapping compound to the threads and run the nut up and down on the bolt or stud several times to smooth out the surface. Be sure to clean off all traces of lapping compound from the threads and surrounding area before assembling the joint.

075-8.6 REWORKING OF THREADED FASTENER JOINTS

075-8.6.1 FASTENER REMOVAL. All standard threaded fasteners have right-handed threads and should be turned counterclockwise to loosen except when the nut is on the back side of the machinery on which you are working, think about this for a moment. If turning the fastener is difficult due to rust or corrosion, apply penetrating oil to break down the rust and reduce thread friction so that the fastener can be removed without damage. Penetrating oils are listed in the Afloat Shopping Guide under FSC 9150. For propulsion plant equipment in nuclear powered ships, only penetrating fluid per MIL-P-24548 can be used. Apply the chemical liberally to the thread area and to the bearing surface. Try to turn the fastener and then apply more chemical and work the fastener back and forth. This will work the chemical into the thread area and you should then be able to remove it. It helps to let it soak for several hours as these chemicals will seep into the smallest cracks. If you still cannot break the fastener loose and feel that you are about to wring it off, stop and get a torque wrench. Apply about 10 percent more torque than the maximum specified for the fastener you are working on. If the fastener does not loosen, refer to [Section 9](#) where removal of damaged or especially stubborn fasteners is detailed.

075-8.6.2 SUBMARINE FASTENER APPLICATIONS. General guidelines for fasteners for overhaul, repair and conversion of combatant submarines is contained in NAVSEA S9505-AM-GYD-010, **Submarine Fastening Criteria (Non-Nuclear)**. The guidance therein does not supersede torque requirements or procedures of applicable drawings or technical manuals.

075-8.6.3 REWORK/REPLACEMENT OF CLASS 5 INTERFERENCE FIT THREADS. For non-high temperature applications (less than 300°F), Class 5 interference fit studs may be replaced by studs installed using anaerobic-locking compounds. For higher temperature applications, Class 5 (interference fit) studs are required unless specific approval is obtained for use of anaerobic or other thread locking compounds.

075-8.6.3.1 Replacements Using Anaerobic Compounds. The following procedure applies for using replacement studs installed with anaerobic compounds.

- a. Remove existing studs. Retap holes. While Class 3 threads are preferred, Class 2 threads are acceptable.
- b. Clean the hole thoroughly by repeated flushing and scrubbing with a general purpose liquid detergent (MIL-D-16791 or equivalent) and a soft wire brush. See FSC Class 7930 in Afloat Shopping Guide. Blow out all liquid, and dry with oil-free compressed air or a clean cloth.
- c. If studs are in good condition, use thread die to clean up the studs to a Class 3 (preferred) or Class 2 (acceptable) dimensions. If studs are damaged, obtain new studs. Scrub the studs with the same detergent used to clean the tapped holes and dry with oil free compressed air.
- d. Apply primer (activator) as required. See paragraphs [075-5.7.2.2](#) and [075-5.7.2.5](#) for selection of primers. [Table 075-5-5](#) provides stock numbers for primers. Apply sparingly to both male and female threads in accordance with manufacturers directions.
- e. Apply anaerobic locking compound to both male and female threads. (Select anaerobic compound in accordance with the guidance in paragraph [075-5.7.2.](#)) Apply enough compound so that the gap between the male and female threads will be completely filled.
- f. Install the studs using the standout specified on the installation drawing. No lubricant is to be used as the anaerobic compound will act as a lubricant. See paragraph [075-5.7.2.9](#) for more detailed instructions.
- g. After curing is completed, ensure the studs are properly bonded by applying an inspection torque in accordance with paragraph [075-5.7.2.10.7](#).

075-8.6.3.2 Replacement Interference Fit Studs. Because of many slight variations in thread forms used by various activities it is not possible to provide detailed guidance for the replacement of interference fit threads. In many cases the repair or replacement of interference fit threads may be beyond forces afloat capability. The following general information applies.

- a. Reinstallation of a removed interference fit stud may sometimes be feasible. Clean tapped hole and stud in accordance with paragraph [075-8.6.3.1](#), above.
- b. Apply appropriate thread lubricant sparingly.
- c. Install studs using the standout specified on applicable drawings.
- d. Subject each stud to an inspection torque the same as for a stud set with anaerobic compound. It is recommended that the torque in [Table 075-5-6](#) be used. If a torque wrench is not available, any unused (new) self-locking nut with a plastic element may be used. If a self-locking nut with plastic element is to be installed, it is recommended that the torque in [Table 075-5-6](#) for Grade N Locking Compound be used. If the stud turns when the torque is applied the installation is unsatisfactory.
- e. When installations are unsatisfactory, reinstallation without use of a lubricant and a repeat of the inspection torque may be attempted. If still unsatisfactory, an oversize custom fit stud will be required.

- f. Prior to manufacturing or selecting an oversize stud, measure the tapped hole threads at three places: near the bottom, midway, and three threads from the top of the hole. Take thread readings as accurately as possible.
- g. Provide the tap hole dimensions taken above to an engineering activity (shipyard, NAVSEA) which has a copy of ASME B1.12, Class 5 Interference-Fit Thread. Ask the engineering activity to determine the major pitch diameter required to maintain the same interference as that which would be obtained using the thread forms recommended in paragraph 075-2.2.2.2.1.
- h. Have a stud or studs made to the required dimensions.
- i. Lubricate stud with the appropriate lubricant (see Table 075-4-3 for listing of lubricants).
- j. Install studs to the specified standout length.
- k. Whenever some studs are set with anaerobic compound and others are interference fit, document the installation with a sketch with each location numbered and the set end pitch diameter readings recorded.

075-8.6.4 REMOVAL AND REUSE OF ASSEMBLED STUDS. The procedure for removal and reuse of locking compound assembled studs is as follows:

- a. To remove studs which have been set with anaerobic (or non-anaerobic) locking compound, apply torque alone or in combination with chemicals or heat, as spelled out in paragraph 075-6.1.5.
- b. Inspect the studs for damage as outlined in paragraphs 075-8.3 and 075-8.4. Discard and replace damaged studs. Also inspect the stud holes, repairing damaged threads or installing thread inserts as required (Note: If locking compound is intended for the replacement stud, use it on the thread insert as well).
- c. Brush away the old compound with a wire brush and apply proper primer for the new locking compound. Then reinstall and inspect the stud in accordance with paragraph 075-5.7.2.10.7.

075-8.6.5 STEPPED STUDS. If a thread insert cannot be used and a larger stud size cannot be accommodated, internal thread damage can be remedied by replacing the existing stud with a stepped stud whose set end is one size larger than the existing stud. These stepped studs will not have as much energy absorption as the standard ones they replaced. A slight improvement in energy absorption capacity can be achieved by drilling out the large end such that it has the same tensile stress area as the small end. A fillet with a 1/8-inch radius should be left where the large and small shanks meet to reduce the stress concentration at that point. A slight chamfer can be machined in the opposite hole to accommodate the fillet. Remove the damaged threads in the hole by re-drilling and tapping the hole to the next larger diameter. Then install the stepped stud in the normal manner. Stepped studs shall not be used in hull integrity joints, or for component or equipment bedplate or foundation holddown bolting without specific prior approval from NAVSEA for each application.

SECTION 9.

REMOVING DAMAGED OR STUBBORN THREADED FASTENERS

075-9.1 GENERAL

075-9.1.1 This section provides procedures for removing those fasteners on which all other removal methods (covered in Section 6) have failed. There will always be some fasteners that are either damaged or just stubborn, and even the best workmanship will not get them loose using normal tools and equipment. It is hoped that the

procedures given here will help with those problem fasteners. For reactor plant applications, where maintenance or replacement requires the removal of stuck nuts or studs, removal shall be accomplished in accordance with the procedures provided in NAVSEA 389-0317.

075-9.2 PREVENTING PROBLEMS

075-9.2.1 Paragraph [075-6.1.3](#) discusses preventive techniques to maximize the chances of successfully removing fasteners using normal procedures. These procedures do not guarantee success in every case, but if you follow them the chances of success will be greatly improved.

075-9.3 NORMAL REMOVAL

075-9.3.1 Paragraph [075-6.1.4](#) gives normal threaded fastener removal procedures.

075-9.4 ROUNDED-OFF NUT AND HEAD CORNERS

075-9.4.1 GENERAL. Rounded-off corners, caused by rust or abuse, are a common fastener problem. This problem can be minimized by following the precautions outlined in paragraph [075-6.1.3](#). When this problem does occur, try the procedures in the following paragraphs.

075-9.4.2 NUTS INSTALLED ON THROUGH BOLTS AND BOLT-STUDS. If you are working with a nut installed on a through bolt (or bolt-stud) and don't need to save the bolt (providing personnel and equipment safety will not be compromised and you are sure that the nut is steel), just burn the nut off with a cutting torch. Otherwise, use an abrasive cutoff wheel or a hacksaw. Where access permits, cut diagonally through the nut from the side and into the bolt. You can also saw down through the end of the bolt and nut or just to the side of the bolt, being careful not to cut into the flange. The space you have to work in will dictate which method to use. You can try heating the nut to expand it also. Heat the nut quickly and try to turn it before the bolt heats up. If you need to save the bolt, use the procedures listed below for nuts on studs.

075-9.4.3 NUTS ON STUDS. If you are working with a stud, you may not want to damage the stud itself. You must be careful not to bend the stud or twist it off. Try the following steps in the order given:

1. Clean dirt, paint, and rust off of the nut, especially around the threads and where the nut bears on the flange.
2. Soak the area with a penetrating liquid. See Afloat Shopping Guide, FSC 9150 for penetrants. For propulsion plant equipment in nuclear powered ships, only penetrating fluid per MIL-P-24548 can be used. Allow as much time as is possible for penetration, keeping the thread and bearing areas wet.
3. Always use a six-point box-end wrench or socket. This may work if the corners of the nut were rounded off by a twelve-point wrench. Make sure that the wrench is all the way on the nut and on straight. If using a box-end wrench, use one with the least offset and pull on it in a straight line. If using a socket, use an extension and hold the handle at the top of the extension with one hand so that there is no side force being applied to the extension, only torque. If you are not dealing with delicate machinery and can get it on the nut, try an impact wrench with its heavy duty six-point socket first.
4. If the area you are working in and the equipment will permit it, apply some heat to the nut. Heat the nut quickly and try to turn it before the stud gets hot. The heat will tend to loosen any rust or corrosion and may expand the nut enough to loosen its grip on the threads. See Steps [3](#) and [8](#) for types of wrenches to use.

5. Once you are able to turn the nut, stop, add some penetrating oil and work the nut back and forth. This will work some lubricant into the threads and the nut will usually come off.
6. If at any point you cannot get a grip on the nut to turn it, skip to one of the more drastic procedures listed below.
7. If you can hit the nut with a hammer without damaging the stud or equipment, proceed as follows :
 - a Find a heavy block of steel with square edges; about 10 pounds will do.
 - b Have someone hold the block against one side of the nut.
 - c Find a straight steel bar with one end that you can hold against the opposite side of the nut.
 - d Drive the steel bar against the nut with a heavy machinist hammer. This may deform the nut between the bar and backup block enough to crush the rust in the thread area and allow some penetrating oil to soak in. The nut may turn then.
8. The next step is to try vise-grips or a pipe wrench, depending on the size of the nut.
9. Use of a sharp chisel is the next alternative. Hold the heavy backup block against one side of the nut and cut on the other side from the flat in towards the threads. This may spread the nut enough so that you can turn what is left of it. If you have a nut splitter tool, you can try to cut the nut with it first.
10. If the area and equipment will permit it, you can use a cutting torch to burn a steel nut off without ever touching the threads on the stud. Use a large enough tip and concentrate the preheat on the nut. If you work fast enough and hold the torch at the proper angle, the stud will not get hot enough to burn when you cut in the oxygen. Practice on some spare fasteners until you feel comfortable doing it.

075-9.4.4 CAPSCREWS. Capscrews present a somewhat different problem. If the corners were rounded off while trying to loosen the fastener, the threads may well be seized in the tapped hole. If this is the case, the fastener will probably twist off at the top of the hole. You do not want this to happen as it will be more difficult to drill out the remains of the fastener. If the corners of the head were just eaten away by rust, try some of the steps listed above for removing nuts on studs. If the threads are seized, do the following:

1. Locate the center of the head as precisely as you can. Take your time and do it carefully.
2. Determine the diameter of the shank and drill down through the head with a drill one size larger than the shank.
3. If you cannot drill the head (it may be too hard), grind it off.
4. Disassemble the equipment, if possible, and treat the fastener as a broken stud. Once you have relieved the tensile load on the capscrew by removing the head and gotten the equipment out of the way, you may be able to turn the fastener by the shank.

NOTE

Saving a portion of the unthreaded shank of the capscrew will allow you to find the center of the fastener for drilling it out of the hole.

075-9.5 SEIZED THREADS

075-9.5.1 The removal procedures for seized threads are essentially the same as those for rounded-off corners except you do not have the problem of how to turn the nut or capscrew.

075-9.6 BROKEN STUDS AND CAPSCREWS

075-9.6.1 GENERAL. Because both broken studs and capscrews are treated essentially the same except for class 5 fit studs or studs set with anaerobic locking compound, only studs will be referred to in the following paragraphs.

075-9.6.2 NONLOCKED STUDS. If the stud broke while tightening it, but it is not seized in the hole, you may be able to remove it with an ezy-out.

NOTE

If the stud is protruding enough to get a pair of vise grips engaged, try this before drilling for ezy-out.

075-9.6.2.1 Drilling an Axial Hole in a Stud. Before using the ezy-out, the first, and most important step is to find the center of the broken fastener. This is not easy as most studs break off at the top of the hole. From this location it is very difficult to find the center of the fastener. The complete diameter of the hole or the fastener cannot be seen and the spiral of the threads shifts the apparent center to one side. This is why it is so important to save some of the unthreaded shank of the capscrew to help in finding the fastener center. When you find the fastener center, carefully centerpunch it. Using a small drill bit, about one-fourth the diameter of the stud or 1/4 inch, whichever is less, drill a straight pilot hole down through the length of the stud. If the hole is not centered and you used a small drill bit, you may be able to true up the hole with a die-grinder. If possible, use a drill fixture to align the drill and hold it true with the stud centerline.

075-9.6.2.1.1 If some of the broken stud is left above the hole, use a drill guide included in a broken stud removal kit, to center the pilot hole or ask th machine shop to make one as follow:

- a. Find a piece of steel bar stock about 3/8 inch larger in diameter than the stud and three times as long as the diameter of the stud or the length of the broken stud's protrusion plus one inch, whichever is less (see Figure 075-9.1).
- b. Using a lathe or a rigid clamp on a heavy duty press, drill an axial hole in one end of the bar, equal to the stud diameter, and halfway down the length of the bar.
- c. Without disturbing the setup holding the bar and using the drill size you plan to use for the pilot hole, drill the smaller hole the rest of the way through the bar. Then fit the guide over the broken stud and use the small hole to guide the drill. Harden the guide after you make it by preheating with a torch and quenching in water to keep the pilot hole drill from wearing out the guide; you may need it again.

075-9.6.2.2 Using Ezy-outs. If the stud broke from overtightening but the threads are not too badly seized, try using an ezy-out to remove the stud. For these applications, enlarge the hole to about three-fourths of the stud diameter using a standard tapered reamer for the last step. Since the ezy-out is tapered, tapering the hole will allow the ezy-out to distribute its grip over a much larger section of the stud. Since the ezy-out is made of high-strength material it can remove a stud that is larger than itself. A problem occurs when you have already twisted off a full-sized stud trying to remove the threaded part; you have already applied a torque equal to all that a full-sized stud could deliver. In this case, it is questionable whether an ezy-out will work, especially since the ezy-out tends to expand the stud making it fit even tighter in the hole. When you are enlarging the hole, be careful

not to get it off center as you may need to drill the stud out if the ezy-out does not work. Be careful not to break ezy-out in the hole. Because the ezy-out is made of hardened material it will be very hard to drill out.

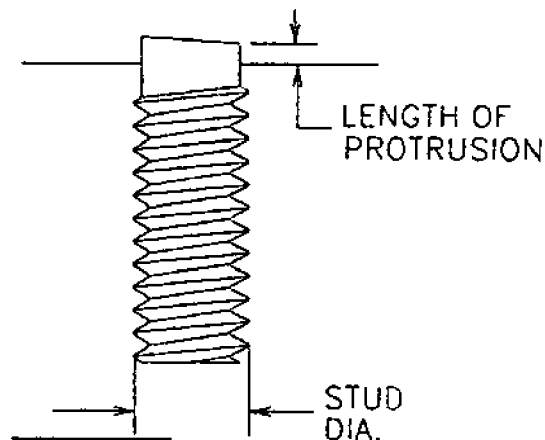
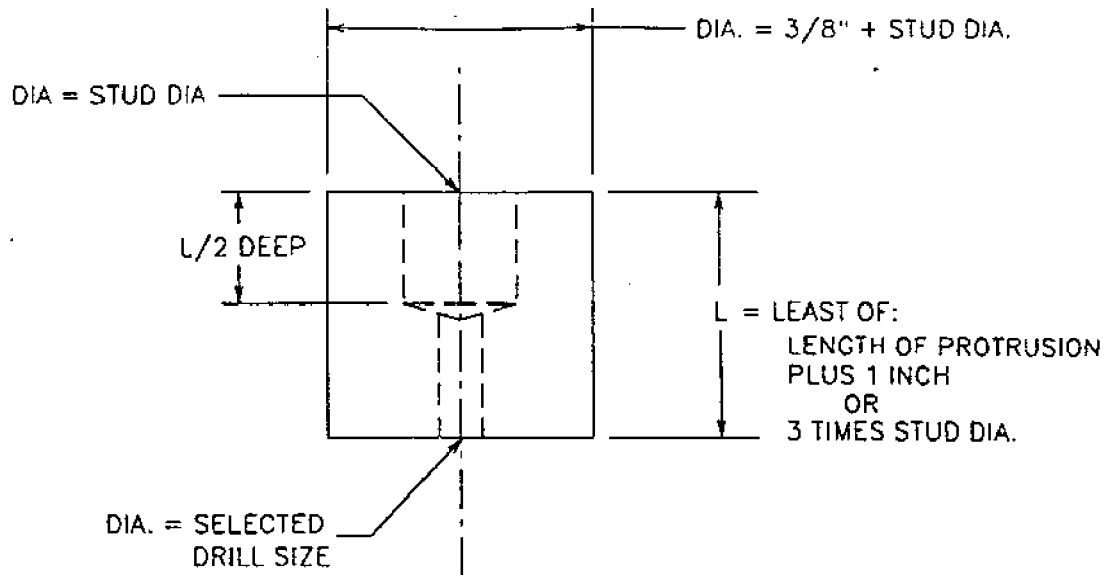

075-9-1 Broken Stud Drill Guide Removal Device

075-9.6.2.3 Drilling Out the Stud. If the stud threads are seized you will have to drill out the stud. This is rarely a completely satisfactory process as some of the threads always seem to get damaged in the process. After drilling the pilot hole to help guide the larger drill, select a drill a couple of sizes smaller than the drill size for the tapped hole. This is to allow for errors in centering the pilot hole. As you drill, examine the sides of the hole to see if you are breaking through to the threads. If you do break through, change to a smaller drill bit and complete the hole. Next, chip out the remains of the stud with a small chisel, a pick, a starting tap, or anything else that will work. If the hole is centered, drill through to the threads all the way down and the remains of the stud will unwind fairly easily.

075-9.6.2.4 Using EDM Equipment. If you are working on an expensive or difficult-to-replace piece of equipment, avoid damaging the threaded hole. Broken studs can be removed with no damage to the threads in the hole by using Electric Discharge Machining (EDM) equipment. (Note: This equipment may also be called a metal disintegrator.) The EDM works through the creation of a series of intermittent electric arcs that break down the hardest metals into very small particles. This cutting action is accomplished with an electrode in the head of the device which vibrates as it cuts. As the EDM cuts, coolant is pumped through the electrode to wash away the powdered metal. Larger repair facilities either have this equipment or can get it. It will eat out the stud, or broken tap, without touching the tapped hole internal threads. There are both portable and larger, fixed EDM machines.

075-9.6.2.5 Power Driven Broken Bolt Extractor (NSN 5130-01-387-7451). This kit can be used to remove 1/4-, 5/16-, 3/8- and 1/2-inch diameter screws. Unlike conventional extractors which require drills, center drills, center punches, hammers, and wrenches, the power driven broken bolt extractor requires only a reversible power drill. It is very effective in removing bolts and studs without damaging the threads in the hole. Since this tool can be driven by electrical power, it has the ability of applying tremendous torque during the extraction process. Essentially, this extractor has the following two main parts.

- a. The collet/extractor
- b. This part is equipped with seven serrations, which bite onto the broken bolt.
The drill tip and body

The tip is made out of high quality tool steel and is heat treated. It is able to drill into grade 8 and stainless steel bolts. The tip is equipped with self-centering feature to obtain perfect centering of the bolt. The tip is left hand cutting edge. This feature helps to loosen and sometimes even turn the bolt out during drilling. The body is short and tough. This feature helps the user control the tip with ease, while adding freedom and flexibility in close quarters. Follow instruction supplied with the kit.

075-9.6.3 CLASS 5 FIT AND LOCKED STUDS. If you have a broken, class 5 fit stud, start with the drilling procedure (paragraph [075-9.6.2.1](#)) or use EDM equipment (paragraph [075-9.6.2.4](#)) to remove the stud. If you think you may have to install an oversize stud anyway, drill a pilot hole and then drill the new size tap hole. If you have a low-temperature application and can use an anaerobic thread-locking compound, try to remove the broken stud and enlarge the hole threads to a class 3 fit. If the broken stud was locked with anaerobic compound, apply 500° heat to the area to break down the locking compound. Then follow the procedures for nonlocked removal. If you cannot use heat, go on to the drilling or EDM procedures.

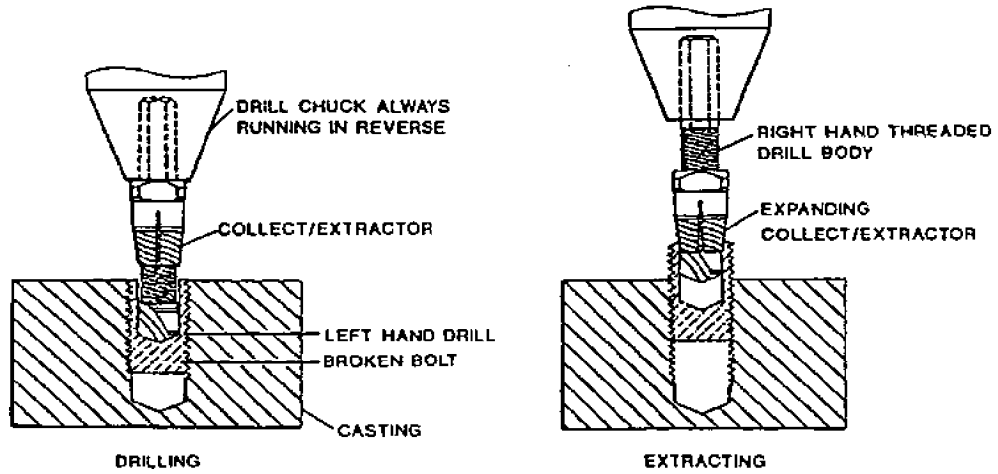

075-9-2 Broken Bolt Extractor

REAR SECTION

NOTE

TECHNICAL MANUAL DEFICIENCY/EVALUATION EVALUATION REPORT (TMDER) Forms can be found at the bottom of the CD list of books. Click on the TMDER form to display the form.

